

An overview of PATENTSCOPE



PATENTSCOPE

- Looking for a specific document
 - Figuring out if what you have in mind already exists
 - Finding out what your competitors are doing
 - Finding out for the latest technology trends
-
- Complete beginner
 - Advanced user

<https://patentscope.wipo.int/>







Content

1

All published PCT applications

2

Data shared by national and regional offices:

a. own data

b. national phase entries

3

Non- patent literature

PATENTSCOPE Simple Search

Using PATENTSCOPE you can search 115 million patent documents including 4.8 million published international patent applications (PCT). [Detailed coverage information](#)
PCT publication 07/2024 (15.02.2024) is now available [here](#). The next PCT publication 08/2024 is scheduled for 22.02.2024. [More](#)
Check out the [latest PATENTSCOPE news and features](#)
[PATENTSCOPE Live Chat](#) 

- Contact Us
- FAQs
- FORUM
- PATENTSCOPE HELP**
- TERMS OF USE
- PRIVACY POLICY

Field	Search terms...	Q
Front Page		
Query Examples		

Help

How to Search

- [User's Guide](#)
- [Query Syntax](#)
- [Fields Definition](#)
- [IPC/CPC classification fields](#)
- [Wildcard vs Stemming](#)
- [Tutorials](#)
- [Tips And Tricks](#)
- [Practical exercises](#)
- [Webinars](#)

PATENTSCOPE News

- [Close to 5 Million new Non-Patent Literature Documents Now Available in PATENTSCOPE](#) (Oct 18, 2023)
- [The National Patent Collection of Monaco is Now Available in Patentscope](#) (Oct 4, 2023)
- [Improvement in the Download Options for PCT National Phase Entries in PATENTSCOPE](#) (Sep 15, 2023)
- [The Norwegian and Belgian national patent collections and the F-term & FI classifications are now available in PATENTSCOPE](#) (Jul 12, 2023)
- [Polish Now Available in WIPO Translate in PATENTSCOPE!](#) (Jun 15, 2023)

DATA COVERAGE

- PCT applications
- PCT national phase entry
- National collections
- Non-Patent Literature
- Global Dossier public
- Chemical documents
- Standard ST37 Authority Definition File

National Collections - Data Coverage

[Offices for which PCT national phase information is available](#)

Updated: May 1, 2024

Country	Latest Biblio	Update Frequency	Biblio Data	Abstract	Chemical Data	Chemical indexed	Doc images	OCR (full-text) Indexed	Nb records	
PCT	01.05.2024	Daily	19.10.1978 - 25.04.2024	19.10.1978 -	11.01.1979 - 04.2024	1,006,857	4,843,610	Total: 4,842,813 Arabic: 223 German: 447,771 English: 2,656,415 Spanish: 31,675 French: 152,026 Japanese: 816,502 Korean: 182,655	4,843,610	
				PCT: 4,843,610 Offices: 111,360,908 Overall: 116,204,518						
Cambodia			27.05.2009 - 03.07.2020	27.05.2009 - 28.12.2019					74	
African Regional Intellectual Property Organization [ARIPO]	29.01.2024		03.07.1985 - 27.10.2023	03.07.1985 - 27.10.2023			1,676	Total: 1,671 English: 1,671	4,662	
Argentina	09.04.2024	Monthly	11.02.1965 - 27.03.2024	31.10.1990 - 27.03.2024			10,686	Total: 32,926 Spanish: 32,926	178,645	
Australia	23.04.2024	Weekly	14.01.1900 - 18.04.2024	08.01.1981 - 18.04.2024				Total: 768,658 English: 768,658	1,887,984	

PATENTSCOPE Simple Search

Using PATENTSCOPE you can search 115 million patent documents including 4.8 million published international patent applications (PCT). [Detailed coverage information](#)

PCT publication 07/2024 (15.02.2024) is now available [here](#). The next PCT publication 08/2024 is scheduled for 22.02.2024. [More](#)

Check out the [latest PATENTSCOPE news and features](#)

PATENTSCOPE Live Chat : every Monday from 1:00 PM to 5:00 PM CET

Field
Front Page



Search terms...



Query Examples

Offices

All



- All
- PCT
- Africa
 - African Regional Intellectual Property Organization (ARIPO)
- ARABPAT
 - Egypt
 - Saudi Arabia
- Americas
 - Canada
- LATIPAT
 - Argentina
 - Colombia
 - Dominican Republic
 - Guatemala
 - Nicaragua
 - Uruguay
- Kenya
- Jordan
- Tunisia
- United States of America
- Brazil
- Costa Rica
- Ecuador
- Honduras
- Panama
- South Africa
- Morocco
- Chile
- Cuba
- El Salvador
- Mexico
- Peru

ADVANCED SEARCH

Search terms...

Expand with related terms

Offices
All

Languages
English

Stemming

Single Family Member

Include NPL

FIELD COMBINATION

Operator	Field	Value	
AND	Front Page	Value	?
AND	WIPO Publication Number	Value	?
AND	Application Number	Value	?
AND	Publication Date	Value	?
AND	English Title	Value	
AND	All Classifications	Is Empty: N/A	
AND	Licensing availability	<input type="checkbox"/>	

+ Add another search field - Reset search fields

Offices
All

Languages
English

Stemming

Single Family Member

Include NPL

REFINE OPTIONS

Close

Search

Offices

All



Languages

English



Stemming

Single Family Member

Include NPL

DATA COVERAGE

- PCT applications
- PCT national phase entry
- National collections
- Non-Patent Literature
- Global Dossier public
- Chemical documents
- Standard ST37 Authority Definition File

Non-Patent Literature - Data Coverage

Updated: February 19, 2024

Publisher	Biblio Data with searchable full-text	Nb records
IEEE	01.01.1892 - 01.03.2024	4,981,454
MDPI	13.02.1998 - 23.10.2023	584,390
nature	01.11.1975 - 01.12.2023	145,892
wikipedia	29.01.2001 - 19.02.2021	62,083

DATA COVERAGE

- PCT applications
- PCT national phase entry
- National collections
- Non-Patent Literature
- Global Dossier public
- Chemical documents
- Standard ST37 Authority Definition File

PCT NATIONAL PHASE ENTRY INFORMATION

Since July 1, 2017, designated Offices have been required to notify the International Bureau of information concerning international applications which enter the national phase at their Office.

Display of information in the National Phase tab of PATENTSCOPE for an office indicates that the applicant requested national phase processing for the application concerned in that office. The national entry date and national reference number are supplied by the national office concerned and can be used to retrieve further details from that office, if desired. Please note that absence of information for a given office does not necessarily indicate a non-entry in that office.

While the supply of information has improved since the requirement entered into force, further work needs to be done to improve the breadth and quality of the data and the timeliness of its transmission. The information is therefore updated at different frequencies, depending on the office.

More information on the [requirement and supply of national phase entries](#)

Updated: February 13, 2023

Country ^	From ↕	To ↕	Count ↕
African Regional Intellectual Property Organization (ARIPO)	01.07.1996	14.04.2021	1,078
Algeria	26.04.2000	28.12.2014	3,451
Angola	15.08.2007	21.11.2022	1,619
Armenia	16.04.2018	10.01.2023	18
Australia	05.12.1997	16.01.2023	431,811
Austria	28.11.1980	18.01.2023	3,538
Azerbaijan	03.06.2003	27.12.2022	269
Belarus	05.01.2005	14.08.2018	1,471



PATENTSCOPE Simple Search

Using PATENTSCOPE you can search 115 million patent documents including 4.8 million published international patent applications. PCT publication 07/2024 (15.02.2024) is now available [here](#). The next PCT publication 08/2024 is scheduled for 22.02.2024. [More](#)
Check out the [latest PATENTSCOPE news and features](#)
PATENTSCOPE Live Chat : every Monday from 1:00 PM to 5:00 PM CET

Field Front Page Search terms... Query Examples

Offices All

Search dropdown menu items:

- Simple
- Advanced Search
- Field Combination
- Cross Lingual Expansion
- Chemical compounds

Search ▼ Browse ▼ Tools ▼ Setti

Simple

Advanced Search



Field Combination

Cross Lingual Expansion

Chemical compounds [login required]

PATENTSCOPE Simple Search

Using PATENTSCOPE you can search 115 million patent documents including 4.8 million published international patent applications (PCT). [Detailed coverage information](#)
PCT publication 07/2024 (15.02.2024) is now available [here](#). The next PCT publication 08/2024 is scheduled for 22.02.2024. [More](#)
Check out the [latest PATENTSCOPE news and features](#)
PATENTSCOPE Live Chat : every Monday from 1:00 PM to 5:00 PM CET

Field
Front Page  Search terms... 

- Front Page
- Any Field
- Full Text
- ID/Number
- Int. Classification(IPC)
- Names
- Publication Date

Query Examples



Front Page

Any Field

Full Text

ID/Number

Int. Classification(IPC)

Names

Publication Date

Publication Number WO/2020/148917	Title [EN] A MEASURED POWDER DISPENSER [FR] DISTRIBUTEUR DE POUDRE MESURÉE
Publication Date 23.07.2020	
International Application No. PCT/AU2019/051076	
International Filing Date 13.12.2019	
IPC A47G 19/34 2006.01 G01F 11/24 2006.01 A47J 47/18 2006.01	
Applicants MORELLO, Silvio [AU]/[AU]	
Inventors MORELLO, Silvio	
Agents PATENTEC PATENT ATTORNEYS LL1, 65 York St Sydney, New South Wales 2000, AU	
Priority Data 201900109 17.01.2019 AU	
Publication Language English [EN]	
Filing Language English [EN]	
Designated States <i>View all</i>	
<i>Latest bibliographic data on file with the International Bureau</i>	
	Abstract [EN] A measured powder dispenser has a hopper feeding powder down into a measured dispensing mechanism. The measured dispensing mechanism has an inlet and an outlet and a measuring container operable therebetween. The measuring container is rotatably engaged about a rotation axis generally orthogonal to an inlet axis of the inlet such that an exterior surface thereof moves across the inlet when the measuring container rotates. The measuring container has an interior volume adjustable measurement chamber recessed within the exterior surface such that, in use, at a first rotational position, the measurement chamber aligns with the inlet to accept a measured amount of powder therein from the power container and, when rotated to a second rotational position, the exterior surface seals across the inlet and the measurement chamber aligns with the outlet to dispense the measured amount of powder therefrom. [FR] La présente invention concerne un distributeur de poudre mesurée présentant une trémie introduisant de la poudre vers le bas dans un mécanisme de distribution mesurée. Le mécanisme de distribution mesurée présente une admission et une évacuation et un contenant de mesure pouvant être actionné entre eux. Le contenant de mesure est en prise rotative autour d'un axe de rotation généralement orthogonal à un axe d'admission de l'admission de sorte qu'une surface extérieure de ce dernier se déplace à travers l'admission lorsque le contenant de mesure tourne. Le contenant de mesure présente une chambre de mesure à volume intérieur réglable en retrait à l'intérieur de la surface extérieure de sorte que, lors de l'utilisation, au niveau d'une première position de rotation, la chambre de mesure s'aligne avec l'admission afin d'accepter une quantité de poudre mesurée en son sein à partir du contenant de poudre et, dans une seconde position de rotation, la surface extérieure sur l'admission et la chambre de mesure s'aligne avec l'évacuation afin de distribuer la quantité de poudre mesurée à partir de cette dernière.

说明书

技术领域

技术领域

[0001] 本发明涉及一种样本光学检测装置。

背景技术

背景技术

[0002] 血细胞分析仪大多采用激光散射原理进行测量，原理为：将激光照射在细胞上，通过收集细胞被照射后产生的前向散射光、侧向散射光（90度散射光）和侧向荧光（90度荧光），来对细胞进行分类和计数等。

[0003] 图1为一种血细胞分析仪的光学检测装置，细胞在鞘流的作用下逐个通过流动室，当激光光源发出的光被透镜准直后向通过流动室的细胞照射，照射到细胞上的光会向四面产生散射，通过一收集透镜来收集前向散射光后，再经过一个光源来限定最终到达光电探测器的前向散射光的角度，例如将前向散射光限定为低角度（或者说小角度）的前向散射光——这种角度的前向散射光一般用于测量细胞体积；同时，在与照射到细胞的光线垂直的方向通过另一收集透镜来收集侧向光，收集的侧向光再通过二向色镜发生反射和折射，其中侧向光中的侧向散射光在经过二向色镜时发生反射，然后到达相应的光电探测器——侧向散射光一般用于测量细胞的表面复杂程度，侧向荧光则经过折射或者透镜后再经过一滤光片也到达相应的光电探测器——侧向荧光一般用于测量细胞内核酸含量。

[0004] 图1中的光学检测装置仅有三路测量通道——即低角度前向散射光通道、侧向散射光通道和侧向荧光通道，因此只能基于这三路测量通道获取的信号来对细胞进行分类和计数，这在一定程度上会限制对细胞的进一步分析和计数，即无法做到进行更多维度和更加细致的分类和计数，降低了异常细胞的分类能力；技术人员如果将图1中低角度前向散射光通道替换成增加高角度（或者说大角度）散射光通道，可以直接使用光电探测器来接收大角度前向散射光，但这样接收得到的信号信噪比非常差，因此为了保证信号质量，技术人员通常会采用复杂的多个透镜组合来收集大角度前向散射光再出射给对应的光电探测器，这种做法则会大大增加装置的成本；另外，光学检测装置的尺寸一般偏大，这是由于其光路结构所造成的，例如前向散射光通道一般被设计为折射式的光路结构，因此这会造成光学检测装置的尺寸偏大，尤其是当前向散射光通道用于收集多个角度范围（例如低角度和高角度等）的散射光时。

发明概述

技术问题

[0005] 本发明主要提供一种样本光学检测装置，下面说明。

技术解决方案

[0006] 一实施例的样本光学检测装置，包括：

[0007] 流动室，用于使得待测样本中的细胞逐个通过；

[0008] 光源，用于照射通过所述流动室的细胞；

发明名称：一种样本光学检测装置

Field

Front Page

Search terms...



[Query Examples](#)

- biomarker – cancer biomarker – «cancer biomarker»
- biomarker NEAR cancer
- ~~biomarker NEAR cancer AND 2020~~

Search ▼

Browse ▼

Tools ▼

Simple

Advanced Search

Field Combination

Cross Lingual Expansion

Chemical compounds

		Field Front Page	▼	Value	?
Operator AND	▼	Field English Abstract	▼	Value biomarker NEAR cancer	?
Operator AND	▼	Field Publication Date	▼	Value 2020	?
Operator AND	▼	Field Publication Date	▼	Value	?
Operator AND	▼	Field English Title	▼	Value	?
Operator AND	▼	Field All Classifications	▼	Is Empty: N/A	▼
Operator AND	▼	Field Licensing availability	▼	<input type="checkbox"/>	

[+](#) Add another search field [-](#) Reset search fields

Offices All	▼
Languages English	▼
<input checked="" type="checkbox"/> Stemming	
<input type="checkbox"/> Single Family Member	
<input type="checkbox"/> Include NPI	

316 results [Reset](#) [Search](#)

Search ▼

Browse ▼

Tools ▼

Simple

Advanced Search

Field Combination

Cross Lingual Expansion

Chemical compounds

PATENTSCOPE Advanced Search

EN_AB:(biomarker NEAR cancer) AND DP:(2020) AND PA:genopsy

Query Assistant [Query Examples](#)

 Expand with related terms

Offices
All 

Languages
English 

Stemming

Single Family Member

Include NPL

Reset

Search

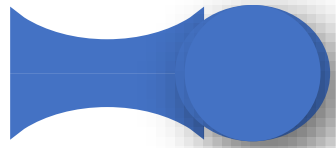

Search: Advanced search

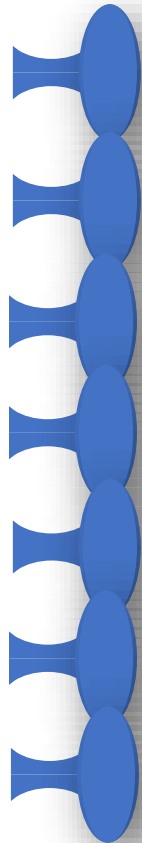

Unlimited number of search terms

Boolean operators: AND, OR, NOT, ANDNOT

Proximity: NEAR, BEFORE

Range operators: [...TO...], {...TO...}

Wildcards: ?, *

Weighting factor: ^

Query assistant

ADVANCED SEARCH ▾

✔ Please enter a valid field... [or use UP/DOWN keys, and TAB or ENTER to select]

applic

Applicant Address

Applicant Address Country

Applicant All Data

Applicant Name

Applicant Nationality

Applicant Residence

Application Date

Application Number

Main Applicant Name

National Phase Application Number

Reset

Search

ADVANCED SEARCH ▾



C: CHEMISTRY; METALLURGY

C01: INORGANIC CHEMISTRY

C02: TREATMENT OF WATER, WASTE WATER, SEWAGE, OR SLUDGE

C03: GLASS; MINERAL OR SLAG WOOL

C04: CEMENTS; CONCRETE; ARTIFICIAL STONE; CERAMICS; REFRACTORIES

C05: FERTILISERS; MANUFACTURE THEREOF

C06: EXPLOSIVES; MATCHES

C07: ORGANIC CHEMISTRY

C08: ORGANIC MACROMOLECULAR COMPOUNDS; THEIR PREPARATION OR CHEMICAL WORKING-UP; COMPOSITIONS BASED THEREON

C09: DYES; PAINTS; POLISHES; NATURAL RESINS; ADHESIVES; COMPOSITIONS NOT OTHERWISE PROVIDED FOR; APPLICATIONS OF MATERIALS NOT OTHERWISE PROVIDED FOR

C10: PETROLEUM, GAS OR COKE INDUSTRIES; TECHNICAL GASES CONTAINING CARBON MONOXIDE; FUELS; LUBRICANTS; PEAT

H: ELECTRICITY

*

PATENTSCOPE Advanced Search ∨

EN_AB:(biomarker NEAR cancer) AND DP:(2020) AND PA:genopsy

Query Assistant [Query Examples](#)

⊕ Expand with related terms

Offices

All

Languages

English

Stemming

Single Family Member

Include NPL

Reset

Search

EN_AB:(biomarker NEAR cancer) AND DP:(2020) AND PA:genopsy



11 results Offices all Languages en Stemming true Single Family Member false Include NPL false



Sort: Relevance ▼ Per page: 10 ▼ View: All ▼

< 1/2 >

Machine translation ▼

1. **WO/2020/204674** METHOD FOR DIAGNOSING CANCER USING CFDNA

WO - 08.10.2020

Int.Class [C12Q 1/6886](#) Appl.No PCT/KR2020/004602 Applicant **GENOPSY, INC.** Inventor CHO, Youngnam

A diagnosis method according to the present invention relates to a technique for concentrating and separating small cfDNA from a liquid specimen such as urine, cerebrospinal fluid, plasma, blood, pleural fluid, or body fluid, and then detecting **biomarkers**, overexpressed in a specific **cancer**, with extreme sensitivity and without a PCR. A detection method according to one example of the present invention does not require a PCR amplification reaction, and thus can significantly reduce the time it takes to diagnose cancer. In addition, the method enables immediate on-site analysis, and can be used as point-of-care testing [POCT] that can simultaneously search a large number of genes in a short time.

2. **1020200117916** METHOD FOR DIAGNOSING PANCREATIC CANCER USING CFDNA

KR - 14.10.2020

Int.Class [C12Q 1/6886](#) Appl.No 1020200041243 Applicant **GENOPSY CO., LTD.** Inventor CHO YOUNGNAM

A diagnosing method of the present invention relates to a technology of concentrating and separating cfDNA having a small size from a liquid sample such as urine, a cerebrospinal fluid, plasma, blood, a pleural fluid, or a body fluid, and then detecting a **biomarker** overexpressed in specific **cancer** super-sensitively without PCR. A detecting method according to an embodiment of the present invention can greatly reduce a time consumed to diagnose cancer as a PCR amplification reaction becomes unnecessary. In addition, the detecting method can be used as point-of-care testing [POCT] enabling direct analysis on the spot and simultaneous searching of multiple genes in a short time. COPYRIGHT KIPO 2021

3. **1020200117917** METHOD FOR DIAGNOSING CANCER USING CFDNA

KR - 14.10.2020

Int.Class [C12Q 1/6886](#) Appl.No 1020200041245 Applicant **GENOPSY CO., LTD.** Inventor CHO YOUNGNAM

A diagnosing method of the present invention relates to a technology of concentrating and separating cfDNA having a small size from a liquid sample such as urine, a cerebrospinal fluid, plasma, blood, a pleural fluid, or a body fluid, and then super-sensitively detecting a **biomarker** overexpressed in specific **cancer** without PCR. A detecting method according to an embodiment of the present invention can greatly reduce a time consumed to diagnose cancer as a PCR amplification reaction becomes unnecessary. In addition, the detecting method can be used as point-of-care testing [POCT] enabling direct analyses on the spot and simultaneous searching of multiple genes in a short time. COPYRIGHT KIPO 2021

4. **1020200117911** METHOD FOR DIAGNOSING BLADDER CANCER USING CFDNA

KR - 14.10.2020

Int.Class [C12Q 1/6886](#) Appl.No 1020200041227 Applicant **GENOPSY CO., LTD.** Inventor CHO YOUNGNAM

A diagnosing method of the present invention relates to a technology of concentrating and separating cfDNA having a small size from a liquid sample such as urine, a cerebrospinal fluid, plasma, blood, a pleural fluid, or a body fluid, and then super-sensitively detecting a **biomarker** overexpressed in specific **cancer** without PCR. A detecting method according to an embodiment of the present invention can greatly reduce a time consumed to diagnose cancer as a PCR amplification reaction becomes unnecessary. In addition, the detecting method can be used as point-of-care testing [POCT] enabling direct analyses on the spot and simultaneous searching of multiple genes in a short time. COPYRIGHT KIPO 2021

Search ▼

Browse ▼

Tools ▼

Simple

Advanced Search

Field Combination

Cross Lingual Expansion

Chemical compounds

PATENTSCOPE Cross Lingual Expansion

Search terms... *

shaving head

Query Language"

English

The language of your query

Expansion Mode:

Automatic

Supervised

Use the **Supervised** mode to select the technical domains, the relevant variants, the languages to translate your query to and the fields to search by

Precision level

High

Influences the precision of the suggested variants.

Highest level considers only the most relevant ones (less suggested variants)

Lowest level considers the less relevant as well (more suggested variants)

Search

EN_AB:("shaving head" OR "cutting head") OR FR_AB:("tête de rasage" OR "tête de coupe" OR "tête de découpe" OR "tête coupante" OR "tête flottante") OR DE_AB:("Schneidkopf" OR "Rasierkopf" OR ')

29,676 results Offices all Languages en Stemming true Single Family Member false Include NPL false

Full Query

Close

Edit

EN_AB:("shaving head" OR "cutting head") OR FR_AB:("tête de rasage" OR "tête de coupe" OR "tête de découpe" OR "tête coupante" OR "tête flottante") OR DE_AB:("Schneidkopf" OR "Rasierkopf" OR "schramkopf" OR "Schrämkopf" OR "Scherkopfes") OR ES_AB:("cabezal de afeitado" OR "cabeza de corte" OR "cabeza de afeitadora que posee" OR "cabezal de aparato de afeitador" OR "disposición de cabeza de afeitado" OR "cabezal cortador" OR "cabeza afeitadora" OR "cabeza de rasurar" OR "dotada con un cabezal rasurador") OR PT_AB:("cabeça de corte" OR "cabeça de barbear" OR "cabeçote cortante" OR "cabeçote de barbear" OR "cabeça de recorte" OR "cabeça fresadora") OR JA_AB:("シェービングヘッド" OR "裁断ヘッド" OR "切断ヘッド" OR "げそりヘッド" OR "切削ヘッド" OR "カッターヘッド" OR "剃りヘッドホルダ" OR "そりヘッド" OR "切削加工ヘッド") OR RU_AB:("и головка бритвы" OR "головки бритвы и" OR "бритвенную головку" OR "головка бритвы" OR "бритвенная головка и" OR "режущая головка" OR "и ножевая головка" OR "врубовой головке") OR ZH_AB:("剃须头" OR "剃须刀刀头" OR "电动剃须刀刀头" OR "切削头" OR "剃削头" OR "剃须刀头" OR "剃刮头" OR "剃削刀头" OR "剃刀头部") OR KO_AB:("면도 헤드" OR "깎는 면도 헤드" OR "커팅 헤드" OR "재단 헤드" OR "절삭 헤드" OR "두부정리 절단장치" OR "면도 헤드가 구비된면도기" OR "절삭 헤드를 구비한" OR "절단용 헤드") OR IT_AB:("testa di taglio" OR "testa di rasatura" OR "testa troncatrice" OR "testa tagliente") OR SV_AB:("skarhuvudet" OR "kapningshuvud" OR "skärhuvud" OR "skerhuvud") OR NL_AB:("scheerblad" OR "scheerkop" OR "scheerhoofd" OR "meskop") OR PL_AB:("tarcie głowica"~22 OR "dla głowica"~22 OR "aparatus głowica"~22 OR "golenia głowica"~22 OR "głowica tnąca urządzesigma" OR "maszynka głowica"~22 OR "tarcie łbem"~22 OR "dla łbem"~22 OR "aparatus łbem"~22) OR DA_AB:("skæreværktøj" OR "skaerehoved" OR "skrehoved" OR "barberapparathoved" OR "barberskraberhoved" OR "fræsehoved")

Sort: Relevance ▼ Per page: 10 ▼ View: All ▼

< 1 / 2,968 >

Machine translation ▼

1. **216422632** MULTIFUNCTIONAL HAIR TRIMMER SET CAPABLE OF BEING USED ON WHOLE BODY

CN - 03.05.2022

Int.Class [B26B 19/38](#) [?](#) Appl.No 202122735308.9 Applicant SHENZHEN YAI SCIENCE AND TECHNOLOGY CO., LTD Inventor LIANG YUBIAO

The utility model provides a multifunctional hair trimmer set capable of being used on the whole body. The multifunctional hair trimmer set comprises a trimmer body, a haircutting head and a shaving head. The haircutting head or the shaving head is installed at the upper end of the trimmer body in a replaceable mode. connecting blocks are installed at the lower end of the haircutting head and the lower end of the shaving head, a connecting groove is formed in the upper end face of the trimmer body, a fixing assembly is arranged in the connecting groove, the connecting blocks are movably connected with the connecting groove, a fixing hole is formed in the connecting groove, and the fixing assembly is arranged in the fixing hole. The hair cutting head or the shaving head is provided with a fixing hole, the fixing assembly is matched with the fixing hole to fix the hair cutting head or the shaving head, the trimmer is provided with a limiting groove, an unlocking assembly is installed in the limiting groove, and the unlocking assembly acts on the fixing assembly and is used for disassembling the hair cutting head or the shaving head. The hairdressing head or the shaving head can be rapidly disassembled and assembled through the fixing assembly and the unlocking assembly, replacement is convenient, and the hairdressing and shaving effects are achieved.

2. **201979543** 手机剃须刀

CN - 21.09.2011

Int.Class [B26B 19/48](#) [?](#) Appl.No 201020684836.5 Applicant 李龙华 Inventor 李龙华

Machine translation ▼

WIPO Translate ▶

- English
- French
- German
- Spanish
- Russian
- Korean
- Japanese
- Chinese
- Arabic
- Portuguese
- Italian
- Finnish
- Polish

1. **216422632** MULTIFUNCTIONAL HAIR TRIMMER SET CAPABLE OF BEING USED ON WHOLE BODY

Int.Class [B26B 19/38](#) ⓘ Appl.No 202122735308.9 Applicant SHENZHEN YAI SCIENCE AND TECHNOLOGY CO., LTD Inventor LIANG YUBIAO

The utility model provides a multifunctional hair trimmer set capable of being used on the whole body. The multifunctional hair trimmer set comprises a trimmer body, a haircutting head and a shaving head. The shaving head is installed at the upper end of the trimmer body in a replaceable mode, connecting blocks are installed at the lower end of the haircutting head and the lower end of the shaving head, a connecting body, a fixing assembly is arranged in the connecting groove, the connecting blocks are movably connected with the connecting groove, a fixing hole is formed in the connecting groove, and the haircutting head or the shaving head is provided with a fixing hole, the fixing assembly is matched with the fixing hole to fix the hair cutting head or the shaving head, the trimmer is provided with a limiting groove, and the unlocking assembly acts on the fixing assembly and is used for disassembling the hair cutting head or the shaving head. The hairdressing head or the shaving head can be replaced through the fixing assembly and the unlocking assembly, replacement is convenient, and the hairdressing and shaving effects are achieved.

CN - 03.05.2022
... or the shaving head is installed on the front face of the trimmer body through the fixing hole. The hairdressing assembly is installed in the limiting groove and assembled through the unlocking assembly.

2. **201979543** 手机剃须刀

Int.Class [B26B 19/48](#) ⓘ Appl.No 201020684836.5 Applicant 李龙华 Inventor 李龙华

手机剃须刀, 属于通讯工具, 主要解决随着生活节奏的加快, 对于男士来说, 往往匆忙而忘记剃须, 对个人形象造成不好的影响的问题。它包括手机主体, 手机主体上设有显示屏和按键, 剃须刀刀头, 电动剃须刀刀头的外侧罩有网罩, 所述电动剃须刀刀头的工作开关设在手机主体的侧面, 电动剃须刀刀头、工作开关和手机主体的蓄电池电连接; 在手机主体上设有显示屏和按键的一体式设计, 能够相结合, 如果出门忘记剃须, 可以找任意一个空闲时间进行剃须, 方便实用。

CN - 21.09.2011
... 没有一个电动剃须刀刀头, 手机和剃须刀的实用功能相结合, 如果出门忘记剃须, 可以找任意一个空闲时间进行剃须, 方便实用。

3. **201808077** 旋转式电动剃须刀刀头组件

Int.Class [B26B 19/14](#) ⓘ Appl.No 201020568845.8 Applicant 浙江光科电器有限公司 Inventor 包伟光

本实用新型涉及一种旋转式电动剃须刀刀头组件, 包括刀头盖、切刀组件以及安置切刀组件的刀头底座, 所述刀头底座的侧面开有让剃须残渣排出的槽或者孔, 这种旋转式电动剃须刀刀头组件具有不需要打开刀头盖能自行排出剃须残渣的特点。

CN - 27.04.2011

4. **1636686** DRY SHAVER

Int.Class [B26B 19/12](#) ⓘ Appl.No 200410104864.4 Applicant Matsushita Electric Works Ltd. Inventor Tsushio Toshiyuki

A dry shaver with a swingable shaving head which is capable of following a user's skin smoothly while keeping an optimum pressing relation with the skin. The shaver includes a grip and a shaving head mounted on top of the grip. The shaving head has a cutting face on its top and has a pair of support points through which the shaving head is supported to the grip. A linkage mechanism is provided to couple the shaving head to the grip for allowing the shaving head to swing relative to the grip. The linkage mechanism includes a pair of cranks each connected at its one end to each one of the support points and connected at the other end to each one of the anchor points on the side of the grip. A frame projects on top of the grip in an overlapping relation with the shaving head to give the anchor points which are positioned upwardly of the support points with respect to a height axis of the grip for suspending the shaving head on top of the grip by the frame. Accordingly, the shaving head is enabled to swing only accompanied with a small vertical displacement of the cutting face from the skin, but with a sufficient angular displacement of the cranks about the anchor points, thereby keeping an optimum contacting pressure against the skin, yet swinging the shaving head to smoothly follow the skin.

CN - 13.07.2005

29,676 results Offices all Languages en Stemming true Single Family Member false Include NPL false



Sort: Relevance ▼ Per page: 10 ▼ View: All ▼

< 1/2,968 >

1. [216422632](#) MULTIFUNCTIONAL HAIR TRIMMER SET CAPABLE OF BEING USED ON WHOLE BODY

CN - 03.05.2022

Int.Class [B26B 19/38](#) Appl.No 202122735308.9 Applicant SHENZHEN YAI SCIENCE AND TECHNOLOGY CO., LTD Inventor LIANG YUBIAO

The utility model provides a multifunctional hair trimmer set capable of being used on the whole body. The multifunctional hair trimmer set comprises a trimmer body, a haircutting head and a shaving head. The haircutting head or the shaving head is installed at the upper end of the trimmer body in a replaceable mode. connecting blocks are installed at the lower end of the haircutting head and the lower end of the shaving head, a connecting groove is formed in the upper end face of the trimmer body, a fixing assembly is arranged in the connecting groove, the connecting blocks are movably connected with the connecting groove, a fixing hole is formed in the connecting groove, and the fixing assembly is arranged in the fixing hole. The hair cutting head or the shaving head is provided with a fixing hole, the fixing assembly is matched with the fixing hole to fix the hair cutting head or the shaving head, the trimmer is provided with a limiting groove, an unlocking assembly is installed in the limiting groove, and the unlocking assembly acts on the fixing assembly and is used for disassembling the hair cutting head or the shaving head. The hairdressing head or the shaving head can be rapidly disassembled and assembled through the fixing assembly and the unlocking assembly, replacement is convenient, and the hairdressing and shaving effects are achieved.

2. [201979543](#) MOBILE PHONE SHAVER

CN - 21.09.2011

Int.Class [B26B 19/48](#) Appl.No 201020684836.5 Applicant 李龙华 Inventor 李龙华

The mobile phone shaver belongs to a communication tool, and mainly solves the problems that as the life rhythm is accelerated, for men, for men, shaving is often forgotten, and bad influences are caused to personal images. An electric shaver head is arranged at one end of the mobile phone main body. A net cover covers the outer side of the electric shaver head. A working switch of the electric shaver head is arranged on the side face of the mobile phone main body. The electric shaver head, the working switch and a storage battery of the mobile phone main body are electrically connected. A protective cover is arranged on the side, provided with the display screen and the key, of the mobile phone main body. According to the present utility model, the practical functions of the mobile phone and the shaver are combined, and if the user forgets shaving, any idle time can be found for shaving, which is convenient and practical.

3. [201808077](#) ROTARY ELECTRIC SHAVER HEAD ASSEMBLY

CN - 27.04.2011

Int.Class [B26B 19/14](#) Appl.No 201020568845.8 Applicant 浙江光科电器有限公司 Inventor 包伟光

The rotary electric shaver head assembly comprises a cutter head cover, a cutter assembly and a cutter head base for containing the cutter assembly, wherein a groove or a hole for discharging shaving residues is formed in the side face of the cutter head base, and the rotary electric shaver head assembly has the characteristic that the shaver head cover does not need to be opened, so that shaving residues can be automatically discharged.

4. [1636686](#) DRY SHAVER

CN - 13.07.2005

Int.Class [B26B 19/12](#) Appl.No 200410104864.4 Applicant Matsushita Electric Works Ltd. Inventor Tsushio Toshiyuki

A dry shaver with a swingable shaving head which is capable of following a user's skin smoothly while keeping an optimum pressing relation with the skin. The shaver includes a grip and a shaving head mounted on top of the grip. The shaving head has a cutting face on its top and has a pair of support points through which the shaving head is supported to the grip. A linkage mechanism is provided to couple the shaving head to the grip for allowing the shaving head to swing relative to the grip. The linkage mechanism includes a pair of cranks each connected at its one end to each one of the support points and connected at the other end to each one of the anchor points on the side of the grip. A frame projects on top of the grip in an overlapping relation with the shaving head to give the anchor points which are positioned upwardly of the support points with respect to a height axis of the grip for suspending the shaving head on top of the grip by the frame. Accordingly, the shaving head is enabled to swing only accompanied with a small vertical displacement of the cutting face from the skin, but with a sufficient angular displacement of the cranks about the anchor points, thereby keeping an optimum contacting pressure against the skin, yet swinging the shaving head to smoothly follow the skin.

Search ▼

Browse ▼

Tools ▼

Simple

Advanced Search

Field Combination

Cross Lingual Expansion

Chemical compounds

CHEMICAL COMPOUNDS SEARCH ▾

Convert structure

Upload structure

Structure editor

Found compounds

Found Markush Formulas

Search type

Compound name



Type an accepted name, commercial name, CAS name, IUPAC name
aspirin

Search for scaffold

Include enumerated Markush structures

Offices

All



Reset

Show in editor

Exact Structure Search

National Biblio. Data

Description

Claims

Drawings

Compounds

Documents

Title

Abstract

Description

Claims

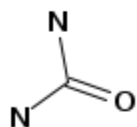
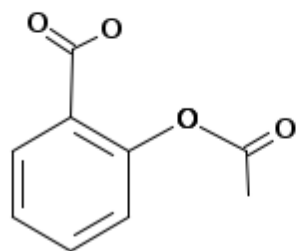

Methionine

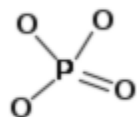
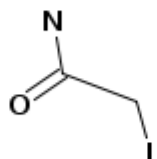
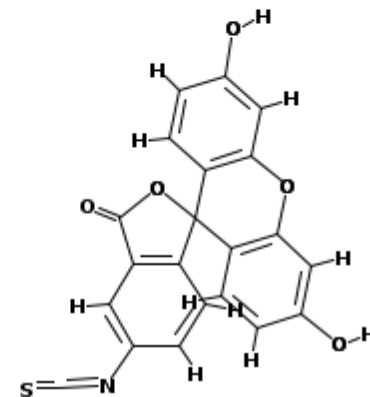
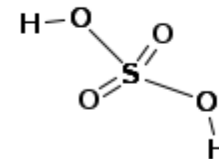
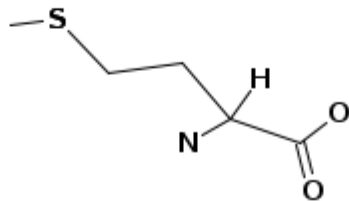

Ca²⁺

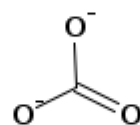

Edetic acid

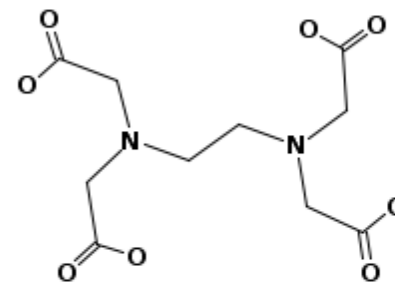

Na⁺ Cl⁻

본 발명은 CAPRIN-1을 종양 마커로 하는 암의 검출 방법에 관한 것이다.

배경기술

암은 전체 사망 원인의 제 1위를 차지하는 질환이고, 현재 행해지고 있는 치료는 수술 요법을 주체로 방사선 요법과 화학 요법을 조합시킨 것이다. 지금까지의 의료 기술의 진보에 의해, 암종에 따라서는 조기 발견할 수 있으면 고칠 수 있는 가능성이 높은 질환이 되고 있다. 그 때문에, 암환자의 체력적, 경제적 부담이 없고, 간편하게 검사할 수 있는 암의 검출 방법이 요구되고 있다.

최근에는, 종양 마커 등의 종양 생산물을 측정하는 방법이 보급되어 왔다. 종양 생산물이란, 종양에 관련되는 항원, 효소, 특정 단백질, 대사산물, 종양 유전자, 종양 유전자 생산물 및 종양 억제 유전자 등을 가리키고, 암 태아성 항원 CEA, 당 단백질 CA19-9, 전립선 특이 항원 PSA, 갑상선에서 생산되는 펩티드 호르몬인 칼시토닌 등이 일부의 암에서 종양 마커로서 암진단에 활용되고 있다. 그러나, 다른 많은 암종에 있어서는 암진단에 유용한 종양 마커는 존재하지 않는다. 또한, 현재 알려져 있는 종양 마커의 대부분은 체액 중에 극히 미량(pg/mL 오더 정도)밖에 존재하지 않기 때문에, 그들을 검출하기 위해서는 고감도한 측정법이나 특수한 기술을 필요로 한다. 이러한 현재 상황 중에서, 각종 암을 간편한 조작으로 고감도로 검출할 수 있는 신규한 암 검사 수단을 제공할 수 있으면, 각종 암에 대한 진단 용도가 열린다고 기대된다.

한편, 최근 새로운 수술법의 개발이나 새로운 항암제의 발견에도 불구하고, 일부 암을 제외하고 대부분의 암에서는 효과적인 암 진단 기술이 확립되어 있지 않다. 그러므로, 암을 조기에 발견할 수 없고, 암의 치료 성적은 그다지 향상되지 않은 것이 현재 상황이다.

최근, 분자생물학이나 암면역학의 진보에 의해, 암에 특이적으로 반응하는 항체나, 암화나 암의 악화에 관련되는 암 항원에 대한 분자 표적약 등, 암 항원류를 타깃으로 한 특이적 암 치료법에의 기대가 높아지고 있다. 그 중에서도, 암세포 상의 항원 단백질을 표적으로 한 암을 치료하기 위한 항체 의약이 복수 상시되어 암 치료에 사용되고 있다. 항체 의약은 암 특이적 치료약으로서 일정 약효를 얻을 수 있으므로 주목받고 있지만, 표적이 되는 항원 단백질의 대부분은 정상세포에도 발현되는 것이고, 항체 투여의 결과, 암세포뿐만 아니라 항원이 발현되는 정상세포도 장애되어버려, 그 결과 생기는 부작용이 문제가 되고 있다. 또한, 암환자에 의해 병인은 다양하기 때문에 암 치료의 효과는 개인차가 매우 크다. 예를 들면, 수술, 화학 요법 또는 방사선 요법에 있어서, 암의 진행 단계에 의해 그 치료 및 예후는 크게 좌우된다. 개체의 다양성에 의해, 동일한 암 치료약에 대해서도 개개인으로 다른 감수성을 가진다는 것이 알려져 있고, 어떤 환자에 유효한 약이 다른 환자에게도 유효하다고는 할 수 없다.

그래서, 미리 환자의 질환 관련 유전자나 단백질의 발현을 측정하고, 어떤 특정 약품이 특정 유전자 또는 단백질을 발현하고 있는 암환자에 대하여 유효할 것인지 아닌지를 평가한 후에, 그 암환자에의 치료약의 투여 결정이 이루어지고 있다. 구체적으로는, 어느 종류의 암에 대한 질환 관련 유전자나 단백질은 측정하는 검출법을 사용하여, 임상 현장에서 암환자 유래의 시료, 예를 들면 혈청이나 조직 중에 암 항원이 존재하는지 아닌지를 검사한 후에 암 항원 특이적인 치료약의 투여 결정이 이루어지고 있다. 예를 들면, 알비투스의 유효성을 예측한 후에 알비투스의 투여를 결정하고 있다. 또, 허셉틴의 적용을 결정하고 있다.

그런데, 반려동물은 가족의 일원으로서 사육되고, 기르는 주인과 동일하는 것이 알려져 있다.

대표적인 반려동물인 개는 인간과 비교하여 7배 빨리 나이를 먹는 것으로 종 등의 혼합백신이 일반적으로 보급되고, 개 파보바이러스 감염증, 개 렙토스피라병이라는 치사율이 높은 감염증이 감소했다. 그 때문에, 개 일로를 걷고 있다. 미국에서는 1년에 약 400만마리의 개가 암으로 진단되기 때문에 발견이 늦어, 종양이 커지고 처음으로 주인이 알고 내원하는 때문에, 수의사가 악성이라고 판단했을 경우에는 수술하지 않고 항암기

실시할 필요가 있다. 수술 후 즉시 항암제 치료를 시작하고, 경과 관찰도 짧은 간격으로 행하는 것이 바람직하다. 따라서, 암에 걸린 반려동물에 있어서도 암 치료약의 투약은 필수적이고, 어떤 종류의 암에 대한 질환관련 유전자나 단백질을 측정하는 검출법이 존재하면, 지금까지 보다 효과적인 치료가 가능하게 되어 주인에게도 수의사에 있어서도 메리트가 크다.

Cytoplasmic-and proliferation-associated protein 1[CAPRIN-1]은 휴지기의 정상세포가 활성화나 세포분열을 일으킬 때에 발현되고, 또한 세포내에서 RNA와 세포내 스트레스 과립을 형성하여 mRNA의 수송, 번역의 제어에 관여하는 것 등이 알려져 있는 세포내 단백질이다. 한편으로, 본 발명자들은 유방암세포의 막 표면에 CAPRIN-1이 고발현하고 있는지, CAPRIN-1에 대한 항체가 유방암세포에 대하여 강한 항종양 효과를 발휘하는지를 밝혀냈다(특허문헌 1). 또한, 세포 표면에 발현하고 있는 CAPRIN-1에 결합하는 항체를 사용하여, 환자에 유래하는 시료 중의 CAPRIN-1의 발현을 측정함으로써, 암의 검출 및 암의 악성도를 평가할 수 있는 것이 보고되고 있다 즉, 세포막 단백질의 하나인 CAPRIN-1은 암 치료 등의 타깃이 될 수 있는 것이 기재되어 있다. 한편 상술한 바와 같이, 암환자의 다양성으로부터 CAPRIN-1을 표적으로 한 치료약, 예를 들면 항체의 투여를 결정하기 위해서는 미리 암환자 유래 시료 중의 CAPRIN-1의 발현을 검증할 필요가 있다. 그러나, 이와 같이 특이적인 치료약을 적용하기 위한 CAPRIN-1의 검출 방법에 관한 보고는 없고, 또한 암환자 시료를 사용한 암을 검출하는 시약은 존재하지 않는다.

선행기술문헌

특허문헌

[특허문헌 0001] WO2010/016526

[특허문헌 0002] WO2010/016527

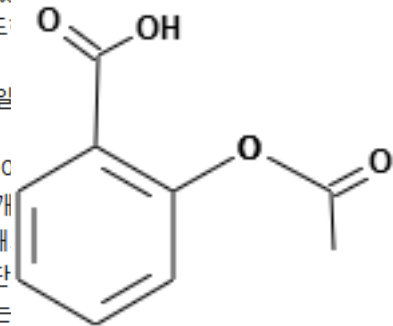

면역 조직 화학 염색 EGFR 검출법 「EGFRpharm(DAKO Corporation)」에 의해 평가하고, 대장암에 있어서의 열 화학 염색 Her2검출법 「허셉 테스트」에 의해 평가하고, 유방암에 있어서의 허셉틴의 유효성을 예측한 후에,

다. 그 때문에, 반려동물의 암 감염에 의해, 기르는 주인이 장래 암을 발병할 위험성이 높은 것을 예측할 수 있

본에서는 약 670만마리, 또한 미국에서는 약 1764만마리라고 알려져 있다. 광견병 예방접종 이외에 5종, 7종, 8플루엔자(컨넬코프), 개 아데노바이러스 2형 감염증(컨넬코프), 개 전염성 간염, 개 코로나바이러스 감염증, 및 고령개는 전체 사육수의 35.5%를 차지하고 있다. 사망 원인도 인간과 같이 암이나 고혈압, 심장병 등이 증가의 160만마리에 어떤 종양이 있다고 알려져 있다. 그러나, 반려동물은 인간과 같이 건강진단이 보급되어 있지 않은 경우, 수술 등의 외과적 요법이나 항암제 등의 투약을 행한다 해도, 이미 너무 늦은 경우가 대부분이다. 그 수술을 행할 경우에도, 마진 확보의 크기나 수술 중의 혈액, 세포 비산 대책이라고 한 수술 중의 대책도 엄중하게

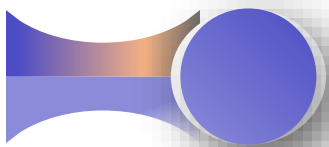

Results

EN_AB:("cable car" OR "cableway" OR "cable wagon"~21 OR "rope car"~21 OR "rope wagon"~21) OR FR_AB:("téléphérique" OR "télécabine" OR "câble" OR "téléférique" OR "blondin" OR "téléphéragé")



137,926 results Offices all Languages all Stemming true Single Family Member false Include NPL false



Sort: Relevance ▼ Per page: 100 ▼ View: All+Image ▼

< 1/1,380 >

Download ▼ Machine translation ▼

1. [0002689928](#) PLANT AND METHOD FOR TRANSPORTATION OVER SUSPENSION ROPEWAY

Int.Class [B61B 12/06](#) ? Appl.No 2015136489 Applicant Inventor БАБА Матъе [FR]

FIELD: transportation. SUBSTANCE: invention relates to transportation by suspension ropeway, in particular, to transportation of people in **cable cars**. Transport installation of suspension ropeway [2] includes at least two cars [3-5], in each of which there is a detachable clamp for disconnection of car and connection of car to suspension ropeway [2]; at least one connecting device [17] of cars [3-5] with suspension ropeway [2]; and at least one bending support [23, 24, 40] of suspension ropeway [2]. At that, transport installation of suspension ropeway also contains detection facility [25-27] intended for detection of movement of the first car connected to suspension ropeway [2] through specified support [23, 24, 40], made with possibility to transfer at least one connection signal when movement is detected, and control means [28] of said connecting device [17] connected to detection means [25-27] and configured to transmit a command to connect at least one second car with suspension ropeway [2] when receiving said connection signal. EFFECT: electric power consumption of the suspension ropeway drive motor is reduced and, due to limitation of generated jerks, passenger comfort is provided. 16 cl, 5 dwg

RU - 29.05.2019

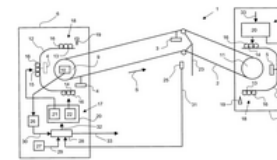

2. [02184665](#) AERIAL TRAMWAY

Int.Class [B61B 7/02](#) ? Appl.No 2000115152/28 Applicant Juzhno-Rossiiskij gosudarstvennyj tekhnicheskij universitet (Novocherkasskij politekhnicheskij institut) Inventor Khal'fin M.N.

FIELD: road building; tramways. SUBSTANCE: proposed aerial tramway has carrying wire **ropes** resting of shoes hinge-secured on line supports. **Cars** are installed on carrying wire **ropes**. **Cars** are moved under action of hauling wire **rope**. Aerial tramway has **car** motion stabilizer which includes hydraulic motor mechanically connected with shoe axle and hydraulic connected with control restrictor. Level is hinge-mounted on line support. Free end of lever is connected with control restrictor by kinematic tie. Lever is connected with line support by means of multiple-core spring to kill vibrations of lever. EFFECT: improved reliability of aerial tramway by adjusting torsional rigidity of shoes. 2 dwg

RU - 10.07.2002

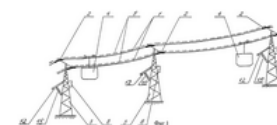

3. [0002723573](#) OPERATING METHOD OF SUSPENDED CABLE RAILWAY SYSTEM AND SUSPENSION CABLEWAY SYSTEM FOR IMPLEMENTATION OF OPERATION METHOD THEREOF

Int.Class [B61B 12/06](#) ? Appl.No 2019119831 Applicant Inventor МАТИС, Михаэль [AT]

FIELD: transportation. SUBSTANCE: invention relates to aerial ropeway. Method of operating suspension ropeway system with at least two stations of aerial ropeway and with at least one carrying rope [13] located between stations of suspended aerial ropeway, at least one vehicle [15] of aerial ropeway is moved by means of at least one traction cable [14]. At that, by means of at least one measuring device, transport positions of said at least one vehicle [15] of aerial ropeway along motion section are determined, said transport positions of said at least one suspension ropeway vehicle [15] along said traffic section are transmitted to a control unit and processed therein, as well as stored therein, and by means of located on said at least one support [12] suspension **cableway** device input into control unit is entered a signal that on this support [12] suspension **cableway** is maintenance work, respectively, installation work. At that, by means of control unit at approach of **cable car** [15] of aerial ropeway to suspension **rope** road [12] support drive for movement of said at least one vehicle [15] of aerial ropeway is adjusted in the sense that the suspension **cableway** vehicle [15] in the area of suspension [12] of the aerial ropeway with a speed which is considerably reduced relative to the operating speed is moved, respectively, delayed. EFFECT: as a result, safety of ropeway, including safety of installation and repair works, is increased. 4 cl, 3 dwg

RU - 16.06.2020

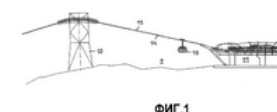

EN_AB:("cable car" OR "cableway" OR "cable wagon"~21 OR "rope car"~21 OR "rope wagon"~21) OR FR_AB:("téléphérique" OR "télécabine" OR "câble" OR "téléférique" OR "blondin" OR "téléphéragé")



137,926 results Offices all Languages all Stemming true Single Family Member false Include NPL false



Sort: Relevance ▼ Per page: 100 ▼ View: All+Image ▼

< 1/1,380 >

Download ▼ Machine translation ▼

1. **0002689928** PLANT AND METHOD FOR TRANSPORTATION OVER SUSPENSION ROPEWAY

Int.Class **B61B 10/00** ? Appl.No 2015136489 Applicant Inventor БАБА Матье (FR)

FIELD: transportation. SUBSTANCE: invention relates to transportation by suspension ropeway, in particular, to transportation of people in **cable cars**. Transport installation of suspension ropeway [2] includes at least two cars [3-5], in each of which there is a detachable clamp for disconnection of car and connection of car to suspension ropeway [2]; at least one connecting device [17] of cars [3-5] with suspension ropeway [2]; and at least one bending support [23, 24, 40] of suspension ropeway [2]. At that, transport installation of suspension ropeway also contains detection facility [25-27] intended for detection of movement of the first car connected to suspension ropeway [2] through specified support [23, 24, 40], made with possibility to transfer at least one connection signal when movement is detected, and control means [28] of said connecting device [17] connected to detection means [25-27] and configured to transmit a command to connect at least one second car with suspension ropeway [2] when receiving said connection signal. EFFECT: electric power consumption of the suspension ropeway drive motor is reduced and, due to limitation of generated jerks, passenger comfort is provided. 16 cl, 5 dwg

RU - 29.05.2019

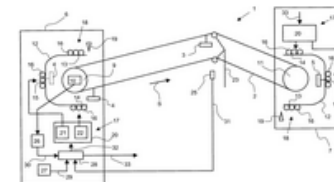

Фиг.1

2. **02184665** AERIAL TRAMWAY

Int.Class **B61B 7/02** ? Appl.No 2000115152/28 Applicant Juzhno-Rossijskij gosudarstvennyj tekhnicheskij universitet (Novocherkasskij politekhnicheskij institut) Inventor Khal'fin M.N.

FIELD: road building; tramways. SUBSTANCE: proposed aerial tramway has carrying wire **ropes** resting of shoes hinge-secured on line supports. **Cars** are installed on carrying wire **ropes**. **Cars** are moved under action of hauling wire **rope**. Aerial tramway has **car** motion stabilizer which includes hydraulic motor mechanically connected with shoe axle and hydraulic connected with control restrictor. Level is hinge-mounted on line support. Free end of lever is connected with control restrictor by kinematic tie. Lever is connected with line support by means of multiple-core spring to kill vibrations of lever. EFFECT: improved reliability of aerial tramway by adjusting torsional rigidity of shoes. 2 dwg

RU - 10.07.2002

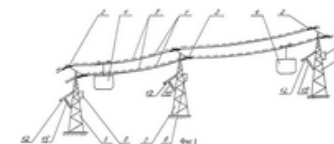

Фиг.1

3. **0002723573** OPERATING METHOD OF SUSPENDED CABLE RAILWAY SYSTEM AND SUSPENSION CABLEWAY SYSTEM FOR IMPLEMENTATION OF OPERATION METHOD THEREOF

Int.Class **B61B 12/06** ? Appl.No 2019119831 Applicant Inventor МАТИС, Михаэль (AT)

FIELD: transportation. SUBSTANCE: invention relates to aerial ropeway. Method of operating suspension ropeway system with at least two stations of aerial ropeway and with at least one carrying rope [13] located between stations of suspended aerial ropeway, at least one vehicle [15] of aerial ropeway is moved by means of at least one traction cable [14]. At that, by means of at least one measuring device, transport positions of said at least one vehicle [15] of aerial ropeway along motion section are determined, said transport positions of said at least one suspension ropeway vehicle [15] along said traffic section are transmitted to a control unit and processed therein, as well as stored therein, and by means of located on said at least one support [12] suspension **cableway** device input into control unit is entered a signal that on this support [12] suspension **cableway** is maintenance work, respectively, installation work. At that, by means of control unit at approach of **cable car** [15] of aerial ropeway to suspension **rope** road [12] support drive for movement of said at least one vehicle [15] of aerial ropeway is adjusted in the sense that the suspension **cableway** vehicle [15] in the area of suspension [12] of the aerial ropeway with a speed which is considerably reduced relative to the operating speed is moved, respectively, delayed. EFFECT: as a result, safety of ropeway, including safety of installation and repair works, is increased. 4 cl, 3 dwg

RU - 16.06.2020



Фиг.1

5. WO2016177877 - VEHICLE FOR AN ENDLESS CABLEWAY



[PCT Biblio. Data](#) [Description](#) [Claims](#) [Drawings](#) [ISR/WOSA/A17\(2\)\(a\)](#) [National Phase](#) [Patent Family](#) [Notices](#) [Documents](#)

[PermaLink](#) [Machine translation](#)

Publication Number

WO/2016/177877

Publication Date

10.11.2016

International Application No.

PCT/EP2016/060175

International Filing Date

06.05.2016

IPC

B61B 12/00 2006.1

CPC

B61B 12/002

Applicants

INNOVA PATENT GMBH [AT]/[AT]
Konrad-Doppelmayr-Strasse 1 6922 Wolfurt,
AT

Inventors

EILER, August

Agents

BEER & PARTNER PATENTANWÄLTE KG
Lindengasse 8 1070 Wien, AT

Priority Data

A 280/2015 06.05.2015 AT

Publication Language

German [de]

Filing Language

German [de]

Title

[DE] FAHRZEUG FÜR EINE UMLAUFSEILBAHN
[EN] VEHICLE FOR AN ENDLESS CABLEWAY
[FR] VÉHICULE POUR UN TÉLÉPHÉRIQUE À CÂBLE SANS FIN

Fig. 3

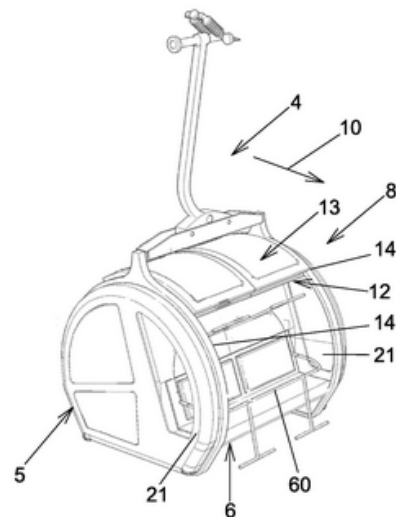

Abstract

[DE] Fahrzeug [1] für eine **Umlaufseilbahn**, welches mit einem umlaufenden Zug- oder Förderseil [2] der **Umlaufseilbahn** in eine Fahrrichtung [10] transportierbar ist, umfassend eine Fahrgasteinheit [8] zur Aufnahme von Fahrgästen, eine Klemmvorrichtung [3] zur Verbindung des Fahrzeugs [1] mit einem umlaufenden Zug- oder Förderseil [2] der **Umlaufseilbahn** und ein Gehänge [4], an welchem die Fahrgasteinheit [8] angebracht ist und welches mit der Klemmvorrichtung [3] verbunden ist, wobei die Fahrgasteinheit [8] mindestens ein, insbesondere zumindest bereichsweise durchsichtig ausgebildetes, Schiebeelement [12, 13] aufweist, welches im Bereich von gegenüberliegenden Rändern von Schiebeführungen [14, 14', 15, 15'] verschiebbar geführt ist. Die Schiebeführungen [14, 14', 15, 15'] verlaufen bogenförmig und das Schiebeelement [12, 13] ist zwischen einer heruntergeschobenen Schließstellung und einer hinaufgeschobenen Offenstellung verschiebbar.

[EN] Vehicle [1] for an endless **cableway**, said vehicle [1] being transportable in a direction of travel [10] by way of an endless traction or conveying cable [2] of the endless **cableway**, comprising a passenger unit [8] for accommodating passengers, a clamping device [3] for connecting the vehicle [1] to a circulating traction or conveying cable [2] of the endless **cableway** and a suspension means [4] to which the passenger unit [8] is attached and which is connected to the clamping device [3], wherein the passenger unit [8] has at least one sliding element [12, 13] that is configured in particular at least regionally in a transparent manner, said sliding element [12, 13] being guided in a slidable manner in the region of opposite edges of sliding guides [14, 14', 15, 15']. The sliding guides [14, 14', 15, 15'] extend in an arcuate manner and the sliding element [12, 13] is slidable between a pushed-down closed position and a pushed-up open position.

EN_AB:("cable car" OR "cableway" OR "cable wagon"~21 OR "rope car"~21 OR "rope wagon"~21) OR FR_AB:("téléphérique" OR "télécabine" OR "câble" OR "téléférique" OR "blondin" OR "téléphérage")

137,926 results Offices all Languages all Stemming true Single Family Member false Include NPL false



Sort: Relevance Per page: 100 View: All+Image

1 / 1,380

Download

Machine translation

Relevance	100	Simple
Pub Date Desc	10	Double
Pub Date Asc	50	All
App Date Desc	100	All+Image
App Date Asc	200	Image
		Multi-columns

OVER SUSPENSION ROPEWAY

Inventor БАБА Матъе (FR)

suspension ropeway, in particular, to transportation of people in cable cars. Transport installation of suspension ropeway [2] includes at least one connecting device [17] of cars [3-5] with suspension ropeway [2]. At that, transport installation of suspension ropeway also contains detection facility [25-27] intended for detection of specified support [23, 24, 40], made with possibility to transfer at least one connection signal when movement is detected, and control facility [25-27] and configured to transmit a command to connect at least one second car with suspension ropeway [2] when receiving said connection signal. EFFECT: electric power consumption of the users: (S1100) The in ropeway drive motor is reduced and, due to limitation of generated jerks, passenger comfort is provided. 16 cl, 5 dwg

RU - 29.05.2019

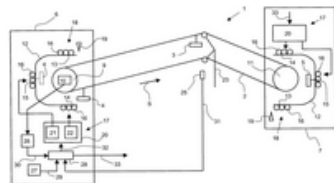

Фиг.1

2. 02184665 AERIAL TRAMWAY

Int.Class B61B 7/02 Appl.No 2000115152/28 Applicant Juzhno-Rossiiskij gosudarstvennyj tekhnicheskij universitet (Novocherkasskij politekhnicheskij institut) Inventor Khal'fin M.N.

FIELD: road building; tramways. SUBSTANCE: proposed aerial tramway has carrying wire ropes resting of shoes hinge-secured on line supports. Cars are installed on carrying wire ropes. Cars are moved under action of hauling wire rope. Aerial tramway has car motion stabilizer which includes hydraulic motor mechanically connected with shoe axle and hydraulic connected with control restrictor. Level is hinge-mounted on line support. Free end of lever is connected with control restrictor by kinematic tie. Lever is connected with line support by means of multiple-core spring to kill vibrations of lever. EFFECT: improved reliability of aerial tramway by adjusting torsional rigidity of shoes. 2 dwg

RU - 10.07.2002

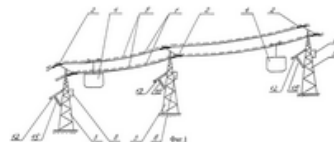

Фиг.1

3. 0002723573 OPERATING METHOD OF SUSPENDED CABLE RAILWAY SYSTEM AND SUSPENSION CABLEWAY SYSTEM FOR IMPLEMENTATION OF OPERATION METHOD THEREOF

Int.Class B61B 12/06 Appl.No 2019119831 Applicant Inventor МАТИС, Михаэль (AT)

FIELD: transportation. SUBSTANCE: invention relates to aerial ropeway. Method of operating suspension ropeway system with at least two stations of aerial ropeway and with at least one carrying rope [13] located between stations of suspended aerial ropeway, at least one vehicle [15] of aerial ropeway is moved by means of at least one traction cable [14]. At that, by means of at least one measuring device, transport positions of said at least one vehicle [15] of aerial ropeway along motion section are determined, said transport positions of said at least one suspension ropeway vehicle [15] along said traffic section are transmitted to a control unit and processed therein, as well as stored therein, and by means of located on said at least one support [12] suspension cableway device input into control unit is entered a signal that on this support [12] suspension cableway is maintenance work, respectively, installation work. At that, by means of control unit at approach of cable car [15] of aerial ropeway to suspension rope road [12] support drive for movement of said at least one vehicle [15] of aerial ropeway is adjusted in the sense that the suspension cableway vehicle [15] in the area of suspension [12] of the aerial ropeway with a speed which is considerably reduced relative to the operating speed is moved, respectively, delayed. EFFECT: as a result, safety of ropeway, including safety of installation and repair works, is increased. 4 cl, 3 dwg

RU - 16.06.2020



Фиг.1

EN_AB:("cable car" OR "cableway" OR "cable wagon"~21 OR "rope car"~21 OR "rope wagon"~21) OR FR_AB:("téléphérique" OR "télécabine" OR "câble" OR "téléférique" OR "blondin" OR "téléphérage")



137,926 results

Offices all Languages all Stemming true Single Family Member false Include NPL false



Sort: Relevance

REFINE OPTIONS

Close

Search

Offices

All

Languages

All

Stemming

Single Family Member

Include NPL

1. [00026899](#)

Int.Class [B61B 1](#)

FIELD: transport: least two cars [3] ropeway [2]; and movement of the means [28] of sa connection signa

2. [02184665](#) AERIAL TRAMWAY

Int.Class [B61B 7/02](#) Appl.No 2000115152/28 Applicant Juzhno-Rossijskij gosudarstvennyj tekhnicheskij universitet (Novocherkasskij politekhnicheskij institut) Inventor Khal'fin M.N.

FIELD: road building; tramways. SUBSTANCE: proposed aerial tramway has carrying wire **ropes** resting of shoes hinge-secured on line supports. **Cars** are installed on carrying wire **ropes**. **Cars** are moved under action of hauling wire **rope**. Aerial tramway has **car** motion stabilizer which includes hydraulic motor mechanically connected with shoe axle and hydraulic connected with control restrictor. Level is hinge-mounted on line support. Free end of lever is connected with control restrictor by kinematic tie. Lever is connected with line support by means of multiple-core spring to kill vibrations of lever. EFFECT: improved reliability of aerial tramway by adjusting torsional rigidity of shoes. 2 dwg

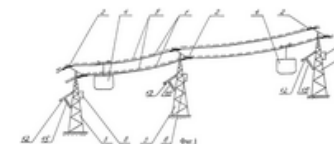

RU - 10.07.2002

3. [0002723573](#) OPERATING METHOD OF SUSPENDED CABLE RAILWAY SYSTEM AND SUSPENSION CABLEWAY SYSTEM FOR IMPLEMENTATION OF OPERATION METHOD THEREOF

Int.Class [B61B 12/06](#) Appl.No 2019119831 Applicant Inventor МАТИС, Михаэль (АТ)

FIELD: transportation. SUBSTANCE: invention relates to aerial ropeway. Method of operating suspension ropeway system with at least two stations of aerial ropeway and with at least one carrying rope [13] located between stations of suspended aerial ropeway, at least one vehicle [15] of aerial ropeway is moved by means of at least one traction cable [14]. At that, by means of at least one measuring device, transport positions of said at least one vehicle [15] of aerial ropeway along motion section are determined, said transport positions of said at least one suspension ropeway vehicle [15] along said traffic section are transmitted to a control unit and processed therein, as well as stored therein, and by means of located on said at least one support [12] suspension **cableway** device input into control unit is entered a signal that on this support [12] suspension **cableway** is maintenance work, respectively, installation work. At that, by means of control unit at approach of **cable car** [15] of aerial ropeway to suspension **rope** road [12] support drive for movement of said at least one vehicle [15] of aerial ropeway is adjusted in the sense that the suspension **cableway** vehicle [15] in the area of suspension [12] of the aerial ropeway with a speed which is considerably reduced relative to the operating speed is moved, respectively, delayed. EFFECT: as a result, safety of ropeway, including safety of installation and repair works, is increased. 4 cl, 3 dwg



RU - 16.06.2020

ФИГ.1

EN_AB:("cable car" OR "cableway" OR "cable wagon"~21 OR "rope car"~21 OR "rope wagon"~21) OR FR_AB:("téléphérique" OR "télécabine" OR "câble" OR "téléférique" OR "blondin" OR "téléphéragé")



137,926 results Offices all Languages all Stemming true Single Family Member false Include NPL false



Sort: Relevance ▼ Per page: 100 ▼ View: All+Image ▼

< 1/1,380 >

Download ▼ Machine translation ▼

100 results
10,000 results
is stored by

1. [0002689928](#) PLANT AND METHOD FOR TRANSPORTATION OVER SUSPENSION ROPEWAY

Int.Class [B61B 12/06](#) ? Appl.No 2015136489 Applicant Inventor БАБА Матье (FR)

FIELD: transportation. SUBSTANCE: invention relates to transportation by suspension ropeway, in particular, to transportation of people in **cable cars**. Transport installation of suspension ropeway [2] includes at least two cars [3-5], in each of which there is a detachable clamp for disconnection of car and connection of car to suspension ropeway [2]; at least one connecting device [17] of cars [3-5] with suspension ropeway [2]; and at least one bending support [23, 24, 40] of suspension ropeway [2]. At that, transport installation of suspension ropeway also contains detection facility [25-27] intended for detection of movement of the first car connected to suspension ropeway [2] through specified support [23, 24, 40], made with possibility to transfer at least one connection signal when movement is detected, and control means [28] of said connecting device [17] connected to detection means [25-27] and configured to transmit a command to connect at least one second car with suspension ropeway [2] when receiving said connection signal. EFFECT: electric power consumption of the suspension ropeway drive motor is reduced and, due to limitation of generated jerks, passenger comfort is provided. 16 cl, 5 dwg

RU - 29.05.2019

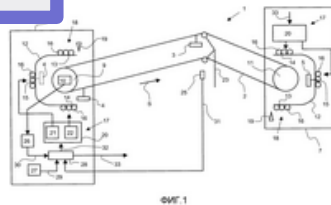

2. [02184665](#) AERIAL TRAMWAY

Int.Class [B61B 7/02](#) ? Appl.No 2000115152/28 Applicant Juzhno-Rossijskij gosudarstvennyj tekhnicheskij universitet (Novocherkasskij politekhnicheskij institut) Inventor Khal'fin M.N.

FIELD: road building; tramways. SUBSTANCE: proposed aerial tramway has carrying wire **ropes** resting of shoes hinge-secured on line supports. **Cars** are installed on carrying wire **ropes**. **Cars** are moved under action of hauling wire **rope**. Aerial tramway has **car** motion stabilizer which includes hydraulic motor mechanically connected with shoe axle and hydraulic connected with control restrictor. Level is hinge-mounted on line support. Free end of lever is connected with control restrictor by kinematic tie. Lever is connected with line support by means of multiple-core spring to kill vibrations of lever. EFFECT: improved reliability of aerial tramway by adjusting torsional rigidity of shoes. 2 dwg

RU - 10.07.2002

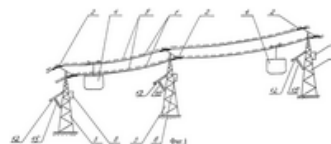

3. [0002723573](#) OPERATING METHOD OF SUSPENDED CABLE RAILWAY SYSTEM AND SUSPENSION CABLEWAY SYSTEM FOR IMPLEMENTATION OF OPERATION METHOD THEREOF

Int.Class [B61B 12/06](#) ? Appl.No 2019119831 Applicant Inventor МАТИС, Михаэль (AT)

FIELD: transportation. SUBSTANCE: invention relates to aerial ropeway. Method of operating suspension ropeway system with at least two stations of aerial ropeway and with at least one carrying rope [13] located between stations of suspended aerial ropeway, at least one vehicle [15] of aerial ropeway is moved by means of at least one traction cable [14]. At that, by means of at least one measuring device, transport positions of said at least one vehicle [15] of aerial ropeway along motion section are determined, said transport positions of said at least one suspension ropeway vehicle [15] along said traffic section are transmitted to a control unit and processed therein, as well as stored therein, and by means of located on said at least one support [12] suspension **cableway** device input into control unit is entered a signal that on this support [12] suspension **cableway** is maintenance work, respectively, installation work. At that, by means of control unit at approach of **cable car** [15] of aerial ropeway to suspension **rope** road [12] support drive for movement of said at least one vehicle [15] of aerial ropeway is adjusted in the sense that the suspension **cableway** vehicle [15] in the area of suspension [12] of the aerial ropeway with a speed which is considerably reduced relative to the operating speed is moved, respectively, delayed. EFFECT: as a result, safety of ropeway, including safety of installation and repair works, is increased. 4 cl, 3 dwg

RU - 16.06.2020

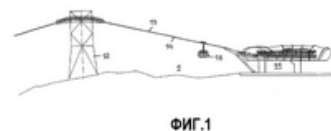

EN_AB:("cable car" OR "cableway" OR "cable wagon"~21 OR "rope car"~21 OR "rope wagon"~21) OR FR_AB:("téléphérique" OR "télécabine" OR "câble" OR "téléférique" OR "blondin" OR "téléphéragé")



137,926 results Offices all Languages all Stemming true Single Family Member false Include NPL false



Sort: Relevance ▼ Per page: 100 ▼ View: All+Image ▼

< 1/1,380 >

Download ▼ Machine translation ▼

1. [0002689928](#) PLANT AND METHOD FOR TRANSPORTATION OVER SUSPENSION ROPEWAY

RU - 29.05.2019

Int.Class [B61B 12/06](#) Appl.No 2015136489 Applicant Inventor БАБА Матье (FR)

FIELD: transportation. SUBSTANCE: invention relates to transportation by suspension ropeway, in particular, to transportation of people in **cable cars**. Transport installation of suspension ropeway [2] includes at least two cars [3-5], in each of which there is a detachable clamp for disconnection of car and connection of car to suspension ropeway [2]; at least one connecting device [17] of cars [3-5] with suspension ropeway [2]; and at least one bending support [23, 24, 40] of suspension ropeway [2]. At that, transport installation of suspension ropeway also contains detection facility [25-27] intended for detection of movement of the first car connected to suspension ropeway [2] through specified support [23, 24, 40], made with possibility to transfer at least one connection signal when movement is detected, and control means [28] of said connecting device [17] connected to detection means [25-27] and configured to transmit a command to connect at least one second car with suspension ropeway [2] when receiving said connection signal. EFFECT: electric power consumption of the suspension ropeway drive motor is reduced and, due to limitation of generated jerks, passenger comfort is provided. 16 cl, 5 dwg

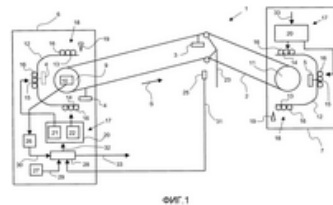

2. [02184665](#) AERIAL TRAMWAY

RU - 10.07.2002

Int.Class [B61B 7/02](#) Appl.No 2000115152/28 Applicant Juzhno-Rossijskij gosudarstvennyj tekhnicheskij universitet (Novocherkasskij politekhnicheskij institut) Inventor Khal'fin M.N.

FIELD: road building; tramways. SUBSTANCE: proposed aerial tramway has carrying wire **ropes** resting of shoes hinge-secured on line supports. **Cars** are installed on carrying wire **ropes**. **Cars** are moved under action of hauling wire **rope**. Aerial tramway has **car** motion stabilizer which includes hydraulic motor mechanically connected with shoe axle and hydraulic connected with control restrictor. Level is hinge-mounted on line support. Free end of lever is connected with control restrictor by kinematic tie. Lever is connected with line support by means of multiple-core spring to kill vibrations of lever. EFFECT: improved reliability of aerial tramway by adjusting torsional rigidity of shoes. 2 dwg

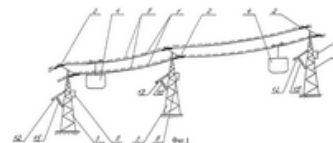

3. [0002723573](#) OPERATING METHOD OF SUSPENDED CABLE RAILWAY SYSTEM AND SUSPENSION CABLEWAY SYSTEM FOR IMPLEMENTATION OF OPERATION METHOD THEREOF

RU - 16.06.2020

Int.Class [B61B 12/06](#) Appl.No 2019119831 Applicant Inventor МАТИС, Михаэль (AT)

FIELD: transportation. SUBSTANCE: invention relates to aerial ropeway. Method of operating suspension ropeway system with at least two stations of aerial ropeway and with at least one carrying rope [13] located between stations of suspended aerial ropeway, at least one vehicle [15] of aerial ropeway is moved by means of at least one traction cable [14]. At that, by means of at least one measuring device, transport positions of said at least one vehicle [15] of aerial ropeway along motion section are determined, said transport positions of said at least one suspension ropeway vehicle [15] along said traffic section are transmitted to a control unit and processed therein, as well as stored therein, and by means of located on said at least one support [12] suspension **cableway** device input into control unit is entered a signal that on this support [12] suspension **cableway** is maintenance work, respectively, installation work. At that, by means of control unit at approach of **cable car** [15] of aerial ropeway to suspension **rope** road [12] support drive for movement of said at least one vehicle [15] of aerial ropeway is adjusted in the sense that the suspension **cableway** vehicle [15] in the area of suspension [12] of the aerial ropeway with a speed which is considerably reduced relative to the operating speed is moved, respectively, delayed. EFFECT: as a result, safety of ropeway, including safety of installation and repair works, is increased. 4 cl, 3 dwg

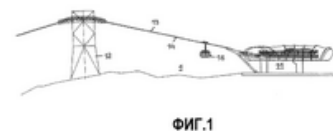



Relevance ▾ 100 ▾ All+Image ▾

Download ▾ Machine translation ▾

< 1/1.275 ▾ >

1. [0002689928](#) PLANT AND METHOD FOR TRANSPORTATION OVER SUSPENSION ROPEWAY

Int.Class [B61B 12/06](#) Appl.No 2015136489 Applicant Inventor БАБА Матье (FR)

FIELD: transportation. SUBSTANCE: invention relates to transportation by suspension ropeway, in particular, to transportation of people in **cable cars**. Transport installation of suspension ropeway [2] includes at least two cars [3-5], in each of which there is a detachable clamp for disconnection of car and connection of car to suspension ropeway [2]; at least one

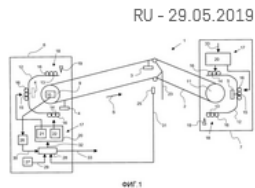

RU - 29.05.2019

2. [02184665](#) AERIAL TRAMWAY

Int.Class [B61B 7/02](#) Appl.No 2000115152/28

Applicant Juzhno-Rossijskij gosudarstvennyj tekhnicheskij universitet (Novocherkasskij politekhnicheskij institut) Inventor Khal'fin M.N.

FIELD: road building; tramways. SUBSTANCE: proposed aerial tramway has carrying wire **ropes** resting of shoes hinge-secured on line supports. **Cars** are installed on carrying wire **ropes**. **Cars** are moved under action of hauling wire **rope**. Aerial tramway has **car** motion stabilizer which includes hydraulic motor mechanically connected with shoe axle and hydraulic connected

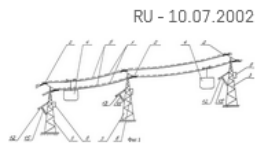

RU - 10.07.2002

3. [0002723573](#) OPERATING METHOD OF SUSPENDED CABLE RAILWAY SYSTEM AND SUSPENSION CABLEWAY SYSTEM FOR IMPLEMENTATION OF OPERATION METHOD THEREOF

Int.Class [B61B 12/06](#) Appl.No 2019119831 Applicant Inventor МАТИС, Михаэль (AT)

FIELD: transportation. SUBSTANCE: invention relates to aerial ropeway. Method of operating suspension ropeway system with at least two stations of aerial ropeway and with at least one carrying rope [13] located between stations of suspended aerial ropeway, at least one vehicle [15] of aerial ropeway is moved by means of at least one traction cable [14]. At that, by means

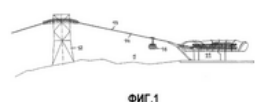

RU - 16.06.2020

4. [3292033](#) VEHICLE FOR AN ENDLESS CABLEWAY

Int.Class [B61B 12/00](#) Appl.No 16722142 Applicant INNOVA PATENT GMBH Inventor EILER AUGUST

Vehicle [1] for an endless **cableway**, said vehicle [1] being transportable in a direction of travel [10] by way of an endless traction or conveying cable [2] of the endless **cableway**, comprising a passenger unit [8] for accommodating passengers, a



EP - 14.03.2018

1. RU0002689928 - PLANT AND METHOD FOR TRANSPORTATION OVER SUSPENSION ROPEWAY

National Biblio. Data Description Claims Drawings Patent Family

PermaLink Machine translation ▾

Office

Russian Federation

Application Number

2015136489

Application Date

27.08.2015

Publication Number

0002689928

Publication Date

29.05.2019

Grant Number

Grant Date

29.05.2019

Publication Kind

C2

IPC

[B61B 12/06](#) [B61B 7/04](#) [B61B 12/04](#)

CPC

[B61B 12/06](#) [Y02T 30/00](#) [B61B 7/04](#)

[B61B 12/04](#)

Inventors

БАБА М

Title

[EN] PLANT AND METHOD FOR TRANSPORTATION OVER SUSPENSION ROPEWAY
[RU] УСТАНОВКА И СПОСОБ ДЛЯ ТРАНСПОРТИРОВКИ ПО ПОДВЕСНОЙ КАНАТНОЙ ДОРОГЕ

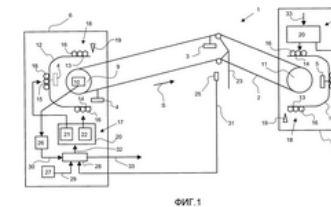

Abstract

[EN] FIELD: transportation. SUBSTANCE: invention relates to transportation by suspension ropeway, in particular, to transportation of people in **cable cars**. Transport installation of suspension ropeway [2] includes at least two cars [3-5], in each of which there is a detachable clamp for disconnection of car and connection of car to suspension ropeway [2]; at least one connecting device [17] of cars [3-5] with suspension ropeway [2]; and at least one bending support [23, 24, 40] of suspension ropeway [2]. At that, transport installation of suspension ropeway also contains detection facility [25-27] intended for detection of movement of the first car connected to suspension ropeway [2] through specified support [23, 24, 40], made with possibility to transfer at least one connection signal when movement is detected, and control means [28] of said connecting device [17] connected to detection means [25-27] and configured to transmit a command to connect at least one second car with suspension ropeway [2] when receiving said connection signal. EFFECT: electric power consumption of the suspension ropeway drive motor is reduced and, due to limitation of generated jerks, passenger comfort is provided. 16 cl, 5 dwg

[RU] Изобретение относится к транспортировке по **подвесной канатной дороге**, в частности к транспортировке людей в **вагонах канатных дорог**. Транспортная установка **подвесной канатной дороги** [2] содержит по меньшей мере два **вагона** [3-5], в каждом из которых предусмотрен отсоединяемый зажим для отсоединения **вагона** и соединения **вагона** с **подвесной канатной дорогой** [2]; по меньшей мере одно соединительное устройство [17] **вагона** [3-5] с **подвесной канатной дорогой** [2]; и по меньшей мере одну изгибающую опор

EN_AB:("cable car" OR "cableway" OR "cable wagon"~21 OR "rope car"~21 OR "rope wagon"~21) OR FR_AB:("téléphérique" OR "télécabine" OR "câble" OR "téléférique" OR "blondin" OR "téléphéragé")



37,926 results Offices all Languages all Stemming true Single Family Member false Include NPL false



Sort: Relevance ▼ Per page: 100 ▼ View: All+Image ▼

< 1/1,380 >

Download ▼ Machine translation ▼

1. [0002689928](#) PLANT AND METHOD FOR TRANSPORTATION OVER SUSPENSION ROPEWAY

RU - 29.05.2019

Int.Class [B61B 12/06](#) Appl.No 2015136489 Applicant Inventor БАБА Матье (FR)

FIELD: transportation. SUBSTANCE: invention relates to transportation by suspension ropeway, in particular, to transportation of people in **cable cars**. Transport installation of suspension ropeway [2] includes at least two cars [3-5], in each of which there is a detachable clamp for disconnection of car and connection of car to suspension ropeway [2]; at least one connecting device [17] of cars [3-5] with suspension ropeway [2]; and at least one bending support [23, 24, 40] of suspension ropeway [2]. At that, transport installation of suspension ropeway also contains detection facility [25-27] intended for detection of movement of the first car connected to suspension ropeway [2] through specified support [23, 24, 40], made with possibility to transfer at least one connection signal when movement is detected, and control means [28] of said connecting device [17] connected to detection means [25-27] and configured to transmit a command to connect at least one second car with suspension ropeway [2] when receiving said connection signal. EFFECT: electric power consumption of the suspension ropeway drive motor is reduced and, due to limitation of generated jerks, passenger comfort is provided. 16 cl, 5 dwg

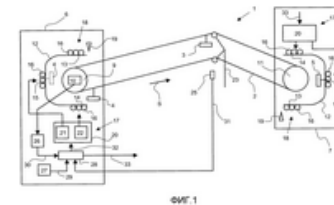

2. [02184665](#) AERIAL TRAMWAY

RU - 10.07.2002

Int.Class [B61B 7/02](#) Appl.No 2000115152/28 Applicant Juzhno-Rossijskij gosudarstvennyj tekhnicheskij universitet (Novocherkasskij politekhnicheskij institut) Inventor Khal'fin M.N.

FIELD: road building; tramways. SUBSTANCE: proposed aerial tramway has carrying wire **ropes** resting of shoes hinge-secured on line supports. **Cars** are installed on carrying wire **ropes**. **Cars** are moved under action of hauling wire **rope**. Aerial tramway has **car** motion stabilizer which includes hydraulic motor mechanically connected with shoe axle and hydraulic connected with control restrictor. Level is hinge-mounted on line support. Free end of lever is connected with control restrictor by kinematic tie. Lever is connected with line support by means of multiple-core spring to kill vibrations of lever. EFFECT: improved reliability of aerial tramway by adjusting torsional rigidity of shoes. 2 dwg

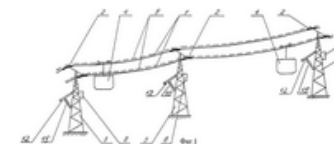

3. [0002723573](#) OPERATING METHOD OF SUSPENDED CABLE RAILWAY SYSTEM AND SUSPENSION CABLEWAY SYSTEM FOR IMPLEMENTATION OF OPERATION METHOD THEREOF

RU - 16.06.2020

Int.Class [B61B 12/06](#) Appl.No 2019119831 Applicant Inventor МАТИС, Михаэль (AT)

FIELD: transportation. SUBSTANCE: invention relates to aerial ropeway. Method of operating suspension ropeway system with at least two stations of aerial ropeway and with at least one carrying rope [13] located between stations of suspended aerial ropeway, at least one vehicle [15] of aerial ropeway is moved by means of at least one traction cable [14]. At that, by means of at least one measuring device, transport positions of said at least one vehicle [15] of aerial ropeway along motion section are determined, said transport positions of said at least one suspension ropeway vehicle [15] along said traffic section are transmitted to a control unit and processed therein, as well as stored therein, and by means of located on said at least one support [12] suspension **cableway** device input into control unit is entered a signal that on this support [12] suspension **cableway** is maintenance work, respectively, installation work. At that, by means of control unit at approach of **cable car** [15] of aerial ropeway to suspension **rope** road [12] support drive for movement of said at least one vehicle [15] of aerial ropeway is adjusted in the sense that the suspension **cableway** vehicle [15] in the area of suspension [12] of the aerial ropeway with a speed which is considerably reduced relative to the operating speed is moved, respectively, delayed. EFFECT: as a result, safety of ropeway, including safety of installation and repair works, is increased. 4 cl, 3 dwg

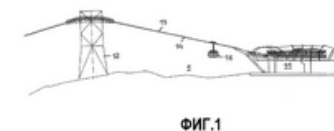

ANALYSIS

Close

Filters Charts Timeseries

Countries		Offices		Applicants		IPC code		CPC code		Publication Dates		Kind code	
PCT	56,160	PCT	56,160	MITSUBISHI ELECTRIC CO	1,239	H01R	11,253	h01r	6,294	1993	1,414	A	62,156
European Patent Office	29,878	European Patent Office	35,255	SIEMENS AG	898	H02G	10,641	h02g	5,488	1994	1,459	B1	27,646
France	17,045	China	23,470	KONE CO	842	H01B	8,630	g02b	4,571	1995	1,529	A1	15,981
China	10,048	United States of America	17,752	BRIDGESTONE CO	753	G02B	7,873	h01b	4,448	1996	1,717	U	5,619
Russian Federation	4,120	France	17,045	SUMITOMO WIRING SYSTEMS LTD	750	B66B	7,780	y10t	3,339	1997	2,108	A4	4,456
Japan	2,177	Canada	6,570	SUMITOMO ELECTRIC INDUSTRIES LTD	691	A61B	4,084	a61b	2,579	1998	2,228	C1	1,567
Russian Federation(USSR data)	1,876	Russian Federation	6,222	YAZAKI CO	639	B61B	3,905	y02e	2,328	1999	2,296	B2	1,533
Canada	1,682	Republic of Korea	6,040	NEXANS	596	H04L	3,481	h04l	2,308	2000	2,698	A2	1,484
Spain	764	Japan	5,166	HITACHI LTD	586	E21B	3,334	h04n	2,066	2001	2,823	B	1,469
United States of America	632	Germany	3,343	ADC TELECOMMUNICATIONS INC	495	H04B	3,199	e21b	1,980	2002	3,009	U1	1,137
Republic of Korea	566	India	2,863	COMMSCOPE TECH LLC	492	H04N	3,127	h04b	1,978	2003	2,950	C	961
United Kingdom	484	Brazil	2,669	AUTONETWORKS TECH LTD	462	F16L	3,012	g06f	1,746	2004	3,095	C2	902
Portugal	353	Mexico	1,959	INNOVA PATENT GMBH	452	G06F	2,920	g01r	1,474	2005	3,046	T3	748
Germany	189	Russian Federation(USSR data)	1,876	HUAWEI TECH CO LTD	444	G01R	2,552	b60r	1,436	2006	3,026	A3	452
Eurasian Patent Organization	169	United Kingdom	1,529	PRYSMIAN SPA	406	B60R	2,471	f16l	1,416	2007	3,456	B3	359
Australia	157	Norway	1,432	HALLIBURTON ENERGY SERVICES INC	371	E01D	2,466	h05k	1,398	2008	3,884	E	352
Brazil	138	New Zealand	862	PEUGEOT CITROEN	369	B66C	2,315	h02j	1,339	2009	3,980	Y	181
Poland	127	Spain	841			B60C	2,064	b66b	1,210	2010	4,028	B8	154
						B63B	2,029	y02t	1,104	2011	4,261	B9	42

SETTINGS

Reset Close Save

Query Office **Result** Interface Others

Result List Language Query Language Result List View

Analysis tab open

Analysis type
Table

Analysis graph
Pie

No of Items/Group
50

- Group by *
- Countries
 - Offices
 - Applicants
 - Inventors
 - IPC code
 - CPC code
 - Publication Dates
 - Filing Dates
 - Kind code

- Download Fields
- Application Number
 - Application Date
 - Publication Numer
 - Publication Date
 - Country Code
 - Title
 - Abstract
 - IPC
 - Applicants
 - Inventors
 - Priority Data
 - National Phase Entries
 - Image

	Offices	Applicants	Inventors	IPC code	CPC code	Publication Dates	Kind code
United States of America	1,372	GENENTECH INC 91	RIEL-MEHAN, MICHAEL 20	G01N 2,905	c12q 1/6886 1,599	2007 91	A 1,786
PCT	922	NOVARTIS AG 73	ZHANG ZHEN 20	C12Q 2,733	c12q 2600/158 1,019	2008 147	A1 1,261
China	730	THE JOHNS HOPKINS UNIVERSITY 70	NAKAMURA YUSUKE 18	A61K 982	g01n 621	2009 179	B2 421
European Patent Office	807	DANA FARBER CANCER INSTITUTE INC 89	DAIGO YATARO 18	C12N 884	a61p 35/00 809	2010 188	B1 402
Canada	427	SOMALOGIC INC 80	GOLD, LARRY 18	C07K 574	c12q 520	2011 249	NPL 361
Republic of Korea	398		JEDDELOH JEFFREY A. 18	A61P 423	c12q 2600/118 472	2012 288	B 162



PATENTSCOPE Simple Search

Using PATENTSCOPE you can search 115 million patent documents including 4.8 million published international patent applications (PCT). [Details](#)
PCT publication 07/2024 (15.02.2024) is now available [here](#). The next PCT publication 08/2024 is scheduled for 22.02.2024. [More](#)
Check out the [latest PATENTSCOPE news and features](#)
PATENTSCOPE Live Chat : every Monday from 1:00 PM to 5:00 PM CET

Field
Front Page

Search terms...

Offices
All

- WIPO Translate
- WIPO Pearl
- IPC Green Inventory
- Portal to patent registers

Query Examples

Translate

[\[Terms & conditions/User guide\]](#)

WIPO Translate is a powerful tool trained specifically to translate patent texts.

(It is not adapted for non-patent translations)

Cut and paste text from any patent document into the box below and select from the available language pairs.

NOTE: WIPO Translate not be used for translating undisclosed patent information or other sensitive data as data transmitted via the translation tool is not encrypted)

Text to be translated:

Language pair:

Domain:

Show concordances:

Translate

Related links:

- [WIPO Translate: Cutting-Edge Translation Tool For Patent Documents Extends Language Coverage](#)
- [Interested in your own version of WIPO Translate? Find out more](#)

Translate

[\[Terms & conditions/User guide\]](#)

WIPO Translate is a powerful tool trained specifically to translate patent texts.
(It is not adapted for non-patent translations)
Cut and paste text from any patent document into the box below and select from the available language pairs.

NOTE: WIPO Translate not be used for translating undisclosed patent information or other sensitive data as data transmitted via the translation tool is not encrypted)

Text to be translated:

Language pair:

Domain:

Show concordances:

Translate

This automatic translation is provided for information only, it may contain discrepancies or mistakes and does not have any juridical value.

- Please hover your mouse over parallel segments of text
- Click to view other proposals
- Select words or phrases on the left to access other translation proposals

<p>본 발명은 폴리비닐클로라이드 및 비닐 클로라이드와 하나 이상의 단량체의 공중합체로부터 선택되는 적어도 하나의 비닐 클로라이드 중합체; 적어도 하나의 가소제; 적어도 하나의 에폭시 수지; 및 카르다놀로 블로킹된 적어도 하나의 이소시아네이트 수지를 포함하는 PVC 플라스틱 조성물에 관한 것이다. 본 발명의 PVC 플라스틱 조성물은 100 °C - 200 °C 에서 짧은 시간 동안의 열처리에 의해 다양한 금속 또는 다양한 금속 언더코트의 표면에 대한 강한 접착을 제공하고 저장 안정성에 있어서 탁월하다. 추가로, 그것은 노닐페놀 블로킹된 이소시아네이트 PVC 접착 촉진제에 비해 도포 동안 개선된 항복값 도상 및 점도 안정성을 갖는 우수한 레올로지 특성을 제공한다.</p>	<p>The present invention relates to a PVC plastisol composition comprising: at least one vinyl chloride polymer selected from polyvinyl chloride and a copolymer of vinyl chloride and one or more monomers; at least one plasticizer; at least one epoxy resin; and at least one isocyanate resin blocked with cardanol. The PVC-plastisol composition of the present invention provides strong adhesion to surfaces of various metals or various metal undercoats by heat treatment for a short time at 100°C -200°C and is unique in storage stability. Additionally, it provides excellent rheological properties with improved yield value and viscosity stability during application as compared to nonylphenol blocked isocyanate PVC leather adhesion promoters.</p>
--	--

Edit translation

Related links:

- [WIPO Translate: Cutting-Edge Translation Tool For Patent Documents Extends Language Coverage](#)
- [Interested in your own version of WIPO Translate? Find out more](#)

본 발명은 폴리비닐클로라이드 및 비닐 클로라이드와 하나 이상의 단량체의 공중합체로부터 선택되는 적어도 하나의 비닐 클로라이드 중 합제; 적어도 하나의 가소제; 적어도 하나의 에폭시 수지; 및 카르다놀로 블로킹된 적어도 하나의 이소시아네이트 수지를 포함하는 PVC 플라스틱 조성물에 관한 것이다. 본 발명의 PVC 플라스틱 조성물은 100 °C - 200 °C 에서 짧은 시간 동안의 열처리에 의해 다양한 금속 또는 다양한 금속 언더코트의 표면에 **뛰어난** 강한 접착을 제공하고 저장 안정성에 있어서 탁월하다. 추가로, 그것은 노닐페놀 블로킹된 이소시아네이트 PVC 접착 촉진제에 비해 도포 동안 개선된 항복값 도상 및 점도 안정성을 갖는 우수한 레올로지 특성을 제공한다.

Edit translation

The present invention relates to a PVC plastisol composition comprising: at least one vinyl chloride polymer selected from polyvinyl chloride and a copolymer of vinyl chloride and one or more monomers; at least one plasticizer; at least one epoxy resin; and at least one isocyanate resin blocked with cardanol. **The PVC-plastisol composition of the present invention provides strong adhesion to surfaces of various metals or various metal undercoats by heat treatment for a short time at 100°C-200°C and is unique in storage stability.** Additionally, it provides excellent

Choose among proposals, or edit the text

The PVC-plastisol composition of the present invention provides strong adhesion to surfaces of various metals or various metal undercoats by heat

Ok

Related links:

- [WIPO Translate: Cutting-Edge Translation Tool For Patent Documents](#)
- [Interested in your own version of WIPO Translate? Find out more](#)

- The PVC - plastisol composition of the present invention provides strong adhesion to surfaces of various metals or various metal undercoats by heat treatment for a short time at 100 ° C-200 ° C and is unique in storage stability
- the pvc-plastisol composition of the present invention provides strong adhesion to surfaces of various metals or various metal undercoats by heat treatment for a short **period of time** at 100°C-200°C and is unique in storage stability
- the pvc plastisol composition of the present invention provides strong adhesion to surfaces of various metals or various metal undercoats by heat treatment for a short time at 100°C-200°C and is unique in storage stability
- the pvc plastisol composition of the present invention provides strong adhesion to surfaces of various metals or various metal undercoats by heat treatment for a short period of time at 100°C-200°C and is unique in storage stability**
- the pvc-plastisol composition of the present invention provides strong adhesion to surfaces of various metals or various metal undercoat by heat treatment for a short time at 100°C-200°C and is unique in storage stability
- the pvc-plastisol composition of the present invention provides strong adhesion to **the surfaces** of various metals or various metal undercoats by heat treatment for a short time at 100°C-200°C and is unique in storage stability
- the pvc-plastisol composition of the present invention provides strong adhesion to **the surface** of various metals or various metal undercoats by heat treatment for a short time at 100°C-200°C and is unique in storage stability
- the pvc-based plastisol composition of the present invention provides strong adhesion to surfaces of various metals or various metal undercoats by heat treatment for a short time at 100°C-200°C and is unique in storage stability
- the pvc-plastisol composition of the present invention provides strong adhesion to surfaces of various metals or various metal undercoats by heat treatment for a short time at 100°C-200° c) and is unique in storage stability
- the pvc-plastisol composition of the present invention provides strong adhesion to surfaces of various metals or various metal undercoats by heat treatment for a short **period of time at 100°C -200° c,** and is unique in storage stability
- the pvc-plastisol composition of the present invention provides strong adhesion to surfaces of various metals or various metal undercoats by heat treatment for a short time at 100 °C -200 °C, and is unique in storage stability
- the pvc **plastisol composition of the present invention provides strong**

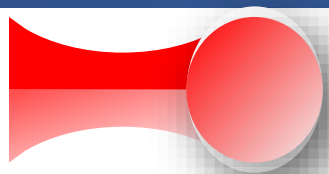

WIPO Pearl

WIPO Translate

WIPO Pearl

IPC Green Inventory

Portal to patent registers



cable car

Search options | Reset

100 HITS for cable car [Filters](#)

Source language All Target language All Subject field All

▶ Terms [cable car](#) [SPRT], [cable drag chain](#) [ELEC], [cable chain](#) [ELEC], [cable carrier chain](#) [ELEC], [cable de estimulación cardiaca](#) [MEDI]...

SPRT / SPORTS FACILITIES [Show full record](#)

▶ DE > Pendelbahn	Reliability 3 / 4	...
▶ > Pendelseilbahn	Reliability 3 / 4	...
▶ EN > aerial tramway	Reliability 3 / 4	...
▶ > cable car	Reliability 3 / 4	...
▶ FR > téléphérique	Reliability 3 / 4	...
▶ KO > 케이블카	Reliability 3 / 4	...

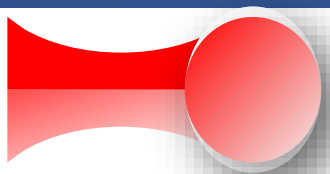

IPC Green Inventory

WIPO Translate

WIPO Pearl

IPC Green Inventory

Portal to patent registers

IPC Green Inventory

The "IPC Green Inventory", developed by the [IPC Committee of Experts](#), facilitates searches for patent information relating to Environmentally Sound Technologies (ESTs), as listed by the [United Nations Framework Convention on Climate Change \(UNFCCC\)](#). ESTs are currently scattered widely across the IPC in numerous technical fields. The Inventory attempts to collect them in one place.

For more information about how to use the IPC Green Inventory please click [here](#).

The Inventory does not purport to be fully exhaustive in its coverage

TOPIC

IPC

PATENTSCOPE

▶ ALTERNATIVE ENERGY PRODUCTION

▶ TRANSPORTATION

▶ ENERGY CONSERVATION

▶ WASTE MANAGEMENT

▶ AGRICULTURE / FORESTRY

▶ ADMINISTRATIVE, REGULATORY OR DESIGN ASPECTS

▶ NUCLEAR POWER GENERATION

TOPIC	IPC	PATENTSCOPE
▶ ALTERNATIVE ENERGY PRODUCTION		
▼ TRANSPORTATION		
▶ VEHICLES IN GENERAL		
▶ VEHICLES OTHER THAN RAIL VEHICLES		
▶ RAIL VEHICLES	B61	B61
▶ MARINE VESSEL PROPULSION		
COSMONAUTIC VEHICLES USING SOLAR ENERGY	B64G 1/44	B64G 1/44
▶ ENERGY CONSERVATION		
▶ WASTE MANAGEMENT		
▶ AGRICULTURE / FORESTRY		
▶ ADMINISTRATIVE, REGULATORY OR DESIGN ASPECTS		
▶ NUCLEAR POWER GENERATION		

PATENTSCOPE Simple Search

Using PATENTSCOPE you can search 115 million patent documents including PCT publication 07/2024 (15.02.2024) is now available [here](#). The next PCT publication is available [here](#).
Check out the [latest PATENTSCOPE news and features](#)
PATENTSCOPE Live Chat : every Monday from 1:00 PM to 5:00 PM CET

Field: Front Page Search terms...

Offices: All

- Browse by Week [PCT]
- Gazette Archive
- Sequence listing
- National Phase Entries**
 - National Phase Entries Full download *ftp*
 - National Phase Entries Incremental download (last 7 days) *ftp*
- Authority File**
 - Authority File Download Standard ST37 *ftp*

Search input field with magnifying glass icon and Query Examples button

PATENTSCOPE Simple Search

Using PATENTSCOPE you can search 115 million patent documents including 4.8 million published international patent applications (PCT). [Detailed coverage information](#)
PCT publication 07/2024 (15.02.2024) is now available [here](#). The next PCT publication 08/2024 is scheduled for 22.02.2024. [More](#)
Check out the [latest PATENTSCOPE news and features](#)
PATENTSCOPE Live Chat : every Monday from 1:00 PM to 5:00 PM CET

Field Front Page	▼	Search terms...	
			Query Examples

Offices All	▼
----------------	---

PATENTSCOPE Simple Search

Using PATENTSCOPE you can search 115 million patent documents including 4.8 million published international patent applications (PCT). [Detailed coverage information](#)
PCT publication 07/2024 (15.02.2024) is now available [here](#). The next PCT publication 08/2024 is scheduled for 22.02.2024. [More](#)
Check out the [latest PATENTSCOPE news and features](#)
PATENTSCOPE Live Chat : every Monday from 1:00 PM to 5:00 PM CET

Field Front Page Search terms...

Offices All

- English
- Français
- Deutsch
- Español
- Português
- Русский
- 日本語
- 中文
- 한국어
- عربي

PATENTSCOPE Simple Search

Using PATENTSCOPE you can search 115 million patent documents including 4.8 million published international patent applications (PCT). [Detailed coverage in](#)
PCT publication 07/2024 (15.02.2024) is now available [here](#). The next PCT publication 08/2024 is scheduled for 22.02.2024. [More](#)
Check out the [latest PATENTSCOPE news and features](#)
PATENTSCOPE Live Chat : every Monday from 1:00 PM to 5:00 PM CET

Field
Front Page

Search terms...

Offices
All

- Contact Us
- FAQs
- FORUM
- PATENTSCOPE HELP**
- TERMS OF USE
- PRIVACY POLICY

HELP

HOW TO SEARCH

- [User's Guide](#)
- [Query Syntax](#)
- [Fields Definition](#)
- [IPC/CPC classification fields](#)
- [Wildcard vs Stemming](#)
- [Tutorials](#)
- [Tips And Tricks](#)
- [Practical exercises](#)
- [Webinars](#)

PATENTSCOPE NEWS

- [National Collection of Matla now Available in Patentscope](#) [Oct 5, 2022]
- [New NPL Content Available In PATENTSCOPE](#) [Sep 7, 2022]
- [National Collection of Switzerland Now Available in PATENTSCOPE](#) [Jun 20, 2022]
- [New RSS feed in PATENTSCOPE](#) [May 19, 2022]
- [National Collection of Austria Now Available in PATENTSCOPE](#) [May 2, 2022]

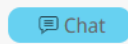

- Contact Us
- FAQs
- FORUM
- PATENTSCOPE HELP
- TERMS OF USE
- PRIVACY POLICY

PATENTSCOPE Simple Search

Using PATENTSCOPE you can search 115 million patent documents including 4.8 million published international patent applications (PCT). [Detailed coverage information](#)
PCT publication 07/2024 (15.02.2024) is now available [here](#). The next PCT publication 08/2024 is scheduled for 22.02.2024. [More](#)
Check out the [latest PATENTSCOPE news and features](#)
[PATENTSCOPE Live Chat](#)

Field
Front Page



Search terms...



Query Examples

Opening hours

- 2pm – 4pm CET on Mondays

PATENTSCOPE Simple Search

Using PATENTSCOPE you can search 115 million patent documents including 4.8 million published international patent applications (PCT). [Detailed coverage in](#)
PCT publication 07/2024 (15.02.2024) is now available [here](#). The next PCT publication 08/2024 is scheduled for 22.02.2024. [More](#)
Check out the [latest PATENTSCOPE news and features](#)
PATENTSCOPE Live Chat : every Monday from 1:00 PM to 5:00 PM CET

Field
Front Page Search terms...

Offices
All

- Contact Us
- FAQs
- FORUM
- PATENTSCOPE HELP**
- TERMS OF USE
- PRIVACY POLICY

HELP

HOW TO SEARCH

- [User's Guide](#)
- [Query Syntax](#)
- [Fields Definition](#)
- [IPC/CPC classification fields](#)
- [Wildcard vs Stemming](#)
- [Tutorials](#)
- [Tips And Tricks](#)
- [Practical exercises](#)
- [Webinars](#)

PATENTSCOPE NEWS

- [National Collection of Matla now Available in Patentscope](#) [Oct 5, 2022]
- [New NPL Content Available In PATENTSCOPE](#) [Sep 7, 2022]
- [National Collection of Switzerland Now Available in PATENTSCOPE](#) [Jun 20, 2022]
- [New RSS feed in PATENTSCOPE](#) [May 19, 2022]

PATENTSCOPE PRACTICAL EXERCISES

This query `EN_AB:(electri* OR electrica* OR electrici* OR support* OR stand* or carry* OR foundat* OR electron*)` cannot be run in PATENTSCOPE why?

- The use of the operator OR is incorrect
- The use of the parentheses is incorrect
- There are too many wildcards

Which query will return results for the search term solar or the combination of search terms wind/turbine in the English description?

- `EN_DE:(solar OR (wind AND turbine))`
- `EN_DE:(solar OR wind AND turbine)`
- `EN_DE:(solar OR ((wind AND turbine)))`

Practical exercises: booklets



PATENTSCOPE exercise booklet

NOVEMBER 2023

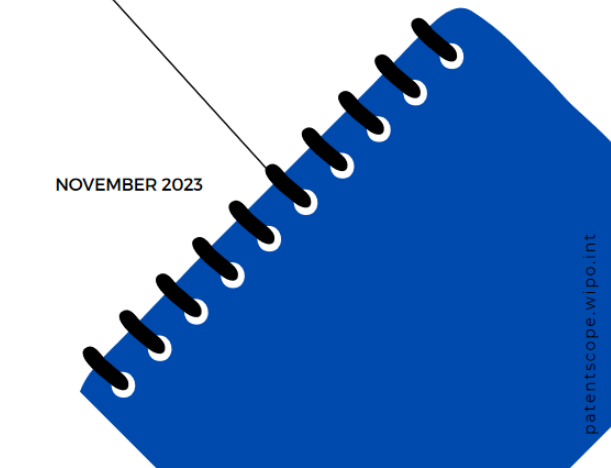

Solutions

I. OPERATOR EXERCISES

1. B
A query with the operator OR will return documents having the keyword tennis or the keyword ball or both keywords.
2. AND; OR; ANDNOT; NOT; BEFORE; NEAR
3. No: query A will return documents having both keyword electric and bicycle with no more than 9 words between them and query B will return documents having the keyword electric before bicycle with no more than 9 words between the 2 keywords. In query B the order of words is taken into account whereas in query A the order is not relevant.
4. To search for an exact term or phrase, use quotation marks.
5. The operator NEAR allow to make sure that 2 keywords or more are close to each other in the result list. If no number is specified after near, the default maximum number of words is 5, the equivalent of NEAR5.
6. Query A as the operator NEAR makes sure that the 2 keywords appear close to each other, in this case no more than 4 words in between the 2 keywords.
7. Documents about microwave ovens will not be included.

II. FIELD EXERCISES

1.
 - a. retrieve documents in Japanese: JA (JA_AB; JA_TI...)
 - b. search information in all the parts of Chinese documents: ZH_ALL
 - c. look for a precise IPC code: IC_EX
 - d. look for an applicant: PAA (all data); PA (name)
 - e. retrieve information in the Spanish claims: ES_CL
 - f. search for all the information related to national phase entry data: NPA
 - g. search information in the text in French: FR_ALLTXT
 - h. retrieve latest kind codes: DTY
2.
 - a. The field IC and the field IC_EX?
IC = International Patent Classification including sub-groups
IC_EX = Specific international Patent Classification
 - b. The field EN_ALL and the field EN_ALLTXT
EN_ALL = English All → all parts in English including Applicant, Inventors etc.
EN_ALLTXT = English All Text → English text parts of the document such as description, claim, abstract
 - c. The columns Countries and Offices in the Analysis in the result list
Countries = national collections
Offices = national collections + PCT applications entering into national phase in those countries
3. NPCC:CN AND NPED:CN-2020*
4. IC:(C10L1/00) AND PCN:DE
5. ISA:US
6. AN:PL2019*

[Home](#) > [PATENTSCOPE](#) > [Webinars](#)

PATENTSCOPE Webinars

WIPO offers free online seminars (webinars) to deliver information, training and updates on the [PATENTSCOPE Search System](#). If you or your organization are interested in a webinar on a specific topic, please [contact us](#).

Note – Participants should connect to the webinar 15-20 minutes before the starting time. Slides from all webinars will be archived.

Register for upcoming webinars

[PATENTSCOPE Overview](#)

February 20, 2024 **Virtual** (English) 17:30 - 18:15 Geneva time

[Online registration](#)

[Overview of PATENTSCOPE](#)

February 22, 2024 **Virtual** (English) 08:30 - 09:30 Geneva time

[Online registration](#)[All PATENTSCOPE webinars](#)

Platform Requirements

Please see the [system requirements](#) for attendees of our webinars.



Search for posts in this group



WIPO PATENTSCOPE Users Community

Public group

[Earn an Active Group badge](#)

<https://www.linkedin.com/groups/9811620/>

Global Brand Database, Global Design Database

Webinars:

- <https://www.wipo.int/reference/en/branddb/webinar/index.html>
- <https://www.wipo.int/reference/en/designdb/webinar/index.html>



A hand is holding a white envelope against a teal background. The envelope is oriented horizontally and has the email address 'patentscope@wipo.int' printed in black text on its flap. The hand is visible at the bottom center, gripping the bottom edge of the envelope.

patentscope@wipo.int